



















THREAD LINE

THREAD LINE INDEX

Índice de machos



















Code.	Picture	Description	Page	Form	Thread Style	Range	Coat.
4990		SC MICRO THREAD MILL R10° 2XD	176	-	M	2 - 12	RACER
4991		SC THREAD MILL R9° - R10° 2XD	177	-	M MF	4 - 16 8 - 16	RACER
48.7010		FORMING TAP HSS-E	180	C	M	3 - 10	TIN Up
48.7016		FORMING TAP HSS-E	181	C	M	12 - 20	TIN Up
40.1040		UNIVERSAL MACHINE TAP HSS-E	182	B	M	3 - 10	BLACK HVA
40.1046		UNIVERSAL MACHINE TAP HSS-E	182	B	M	12 - 20	BLACK HVA
40.1640		UNIVERSAL MACHINE TAP HSS-E TOLERANCE 6G	183	B	M	3 - 10	BLACK HVA
40.1140		UNIVERSAL MACHINE TAP HSS-E	184	B	MF	4 - 20	BLACK HVA
40.1240		UNIVERSAL MACHINE TAP HSS-E	185	B	GAS BSP	1/8 - 1"	BLACK HVA
40.1340		UNIVERSAL MACHINE TAP HSS-E	186	B	UNF SAE	4 - 5/8	BLACK HVA
40.1440		UNIVERSAL MACHINE TAP HSS-E	187	B	UNC	4 - 3/8	BLACK HVA
40.1446		UNIVERSAL MACHINE TAP HSS-E	187	B	UNC	7/16 - 3/4	BLACK HVA
41.6040		UNIVERSAL MACHINE TAP PERFORMANCE HSS-E-PM	188	B	M	2 - 10	TIN Up
41.6046		UNIVERSAL MACHINE TAP PERFORMANCE HSS-E-PM	189	B	M	12 - 20	TIN Up
45.5040		HIGH PERFORMANCE MACHINE TAP HSS-E	190	B	M	2 - 10	DSC
45.5046		HIGH PERFORMANCE MACHINE TAP HSS-E	191	B	M	12 - 30	DSC
45.5144		HIGH PERFORMANCE MACHINE TAP HSS-E	192	B	MF	6 - 24	DSC
45.5245		HIGH PERFORMANCE MACHINE TAP HSS-E	193	B	GAS BSP	1/16 - 1"	DSC
44.0040		MACHINE TAP FOR ALUMINIUM HSS-E	194	B	M	3 - 10	BRIGHT

● First choice ○ Suitable

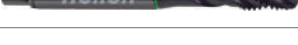

Tolerance	Through Hole	Blind Hole	Norm	600 1200 N/mm ²		HRC		Stainless M	Cast Iron K	Non Ferrous N	Super Alloy S	HSC	HHC	HPC
				42-54	48-63	High Speed Cutting	High Hard Cutting					High Performance Cutting		
-	●	●	HELION	●	●			●	●	○	●	●	●	●
-	●	●	HELION	●	●			●	●	○	●	●	●	●
6HX	●	●	DIN 2174	●				●	●		○	●		●
6HX	●	●	DIN 2174	●				●	●		○	●		●
6H	●		DIN 371	●				●	●	○				
6H	●		DIN 371	●				●	●	○				
6G	●		DIN 371	●				●	●	○				
6H	●		DIN 376	●				●	●	○				
-	●		DIN 5156	●				●	●	○				
2B	●		DIN 374	●				●	●	○				
2B	●		DIN 371/376	●				●	●	○				
2B	●		DIN 371/376	●				●	●	○				
6H	●		DIN 371	●				●	○			●		●
6H	●		DIN 371	●				●	○			●		●
6HX	●		DIN 371	●				●	○		○	●		●
6HX	●		DIN 376	●				●	○		○	●		●
6HX	●		DIN 374	●				●	○		○	●		●
-	●		DIN 5156	○				●	○	○	○	●		●
6H	●		DIN 371							●		●		●

THREAD LINE INDEX

Índice de machos











Code.	Picture	Description	Page	Form	Thread Style	Range	Coat.
44.0046		MACHINE TAP FOR ALUMINIUM HSS-E	195	B	M	12 - 20	BRIGHT
43.2810		HIGH PERFORMANCE MACHINE TAP HSS-E-PM	196	C	M	5 - 10	SHARK
43.2816		HIGH PERFORMANCE MACHINE TAP HSS-E-PM	196	C	M	10 - 14	SHARK
43.2117		HIGH PERFORMANCE MACHINE TAP HSS-E-PM	197	C	MF	5 - 16	SHARK
46.4040		HIGH PERFORMANCE MACHINE TAP HSS-E-PM	198	B	M	3 - 10	SHARK
46.4046		HIGH PERFORMANCE MACHINE TAP HSS-E-PM	199	B	M	12 - 16	SHARK
43.2010		HIGH PERFORMANCE MACHINE TAP HSS-E-PM	200	D	M	3 - 16	SHARK
47.9010		SC MACHINE TAP HARDENED STEELS	201	D	M	3 - 16	SHARK
40.1060		UNIVERSAL MACHINE TAP HSS-E	202	C	M	3 - 10	BLACK HVA
40.1066		UNIVERSAL MACHINE TAP HSS-E	203	C	M	12 - 24	BLACK HVA
40.1050		UNIVERSAL MACHINE TAP HSS-E	204	E	M	3 - 10	BLACK HVA
40.1660		UNIVERSAL MACHINE TAP HSS-E TOLERANCE 6G	205	C	M	3 - 10	BLACK HVA
40.1160		UNIVERSAL MACHINE TAP HSS-E	206	C	MF	4 - 20	BLACK HVA
40.1260		UNIVERSAL MACHINE TAP HSS-E	207	C	GAS BSP	1/8 - 1"	BLACK HVA
40.1360		UNIVERSAL MACHINE TAP HSS-E	208	C	UNF SAE	4 - 5/8	BLACK HVA
40.1460		UNIVERSAL MACHINE TAP HSS-E	209	C	UNC	4 - 3/8	BLACK HVA
40.1466		UNIVERSAL MACHINE TAP HSS-E	209	C	UNC	7/16 - 3/4	BLACK HVA
40.7068		UNIVERSAL MACHINE TAP LONG HSS-E	210	C	M	3 - 20	TIN Up
40.7060		UNIVERSAL MACHINE TAP HSS-E	212	C	M	2 - 10	TIN Up

● First choice ○ Suitable

Tolerance	Through Hole 	Blind Hole 	Norm	600 1200 N/mm ²	HRC		Stainless M	Cast Iron K	Non Ferrous N	Super Alloy S	HSC	HHC	HPC
					42-54	48-63					High Speed Cutting	High Hard Cutting	High Performance Cutting
6H	●		DIN 376					●			●		
6HX	●	●	DIN 376	●				●	○			●	
6HX	●	●	DIN 371	●				●	○			●	
6HX	●	●	DIN 374	●				●	○			●	
6HX	●		DIN 371			○				●		●	
6HX	●		DIN 376			○				●		●	
6HX	●	●	DIN 371/376		●						●	●	
6H	●	●	DIN 371		○	●					●	●	
6H	○	●	DIN 371	●			●	●	○				
6H	○	●	DIN 376	●			●	●	○				
6H	○	●	DIN 371	●			●	●	○				
6G	○	●	DIN 371	●			●	●	○				
6H	○	●	DIN 374	●			●	●	○				
-	○	●	DIN 5156	●			●	●	○				
2B	○	●	DIN 374	●			●	●	○				
2B	○	●	DIN 371/376	●			●	●	○				
2B	○	●	DIN 371/376	●			●	●	○				
6HX	○	●	HELION	●			●	●					
6H	○	●	DIN 371	●			●	●					

THREAD LINE INDEX

Índice de machos

Code.	Picture	Description	Page	Form	Thread Style	Range	Coat.
40.7066		UNIVERSAL MACHINE TAP HSS-E	213	C	M	12 - 24	TIN Up
41.6050		UNIVERSAL MACHINE TAP PERFORMANCE HSS-E-PM	214	C	M	3 - 10	TIN Up
41.6056		UNIVERSAL MACHINE TAP PERFORMANCE HSS-E-PM	214	C	M	12 - 20	TIN Up
45.4060		HIGH PERFORMANCE MACHINE TAP HSS-E	215	C	M	2 - 10	RACER
45.4066		HIGH PERFORMANCE MACHINE TAP HSS-E	215	C	M	12 - 30	RACER
45.4164		HIGH PERFORMANCE MACHINE TAP HSS-E	216	C	MF	6 - 24	RACER
45.3265		HIGH PERFORMANCE MACHINE TAP HSS-E	217	C	GAS BSP	1/16 - 1"	RACER
44.0060		MACHINE TAP FOR ALUMINIUM HSS-E	218	C	M	3 - 10	BRIGHT
44.0066		MACHINE TAP FOR ALUMINIUM HSS-E	219	C	M	12 - 20	BRIGHT
46.4070		HIGH PERFORMANCE MACHINE TAP HSS-E-PM	220	C	M	3 - 10	SHARK
46.4076		HIGH PERFORMANCE MACHINE TAP HSS-E-PM	220	C	M	12 - 16	SHARK

● First choice ○ Suitable

Tolerance	Through Hole 	Blind Hole 	Norm	600 1200 N/mm ²	HRC		Stainless M	Cast Iron K	Non Ferrous N	Super Alloy S	HSC	HHC	HPC
					42-54	48-63					High Speed Cutting	High Hard Cutting	High Performance Cutting
6HX	○	●	DIN 376	●			●	●					
6H	○	●	DIN 371	●			●	●					
6H	○	●	DIN 371	●			●	●					
6HX	○	●	DIN 371	○			●	○	○	○	●		●
6HX	○	●	DIN 376	○			●	○	○	○	●		●
6HX	○	●	DIN 374	○			●	○	○	○	●		●
6HX	○	●	DIN 5156	○			●	○	○	○	●		●
6H	○	●	DIN 371						●				
6H	○	●	DIN 376						●				
6HX	○	●	DIN 371				○			●			●
6HX	○	●	DIN 376				○			●			●

4990

SC MICRO THREAD MILL R10° 2XD

Micro Fresa de roscar de metal duro R10° 2XD

M

SC RACER

600
1200
N/mm² **45**
HRC

55
HRC **GG(G)**

INOX **TITAN**
INCONEL

ALU **UNI**
NE



HA **HPC**

HHC

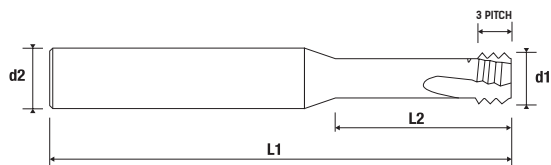

Cod.	M	d1	P	d2	L1	L2	Z	Previous Hole Ø
4990M20040	M2	1,55	0,40	3,00	39	4,50	3	1,60
4990M22045	M2,2	1,65	0,45	6,00	54	5,00	3	1,75
4990M25045	M2,5	1,95	0,45	6,00	54	5,50	3	2,05
4990M30050	M3	2,35	0,50	6,00	54	6,50	3	2,50
4990M35060	M3,5	2,75	0,60	6,00	54	7,50	3	2,90
4990M40070	M4	3,10	0,70	6,00	54	9,00	3	3,30
4990M45075	M4,5	3,40	0,75	6,00	54	10,50	3	3,75
4990M50080	M5	3,80	0,80	6,00	54	12,50	3	4,20
4990M60100	M6	4,65	1,00	6,00	54	14,00	3	5,00
4990M80125	M8	5,95	1,25	6,00	54	18,00	3	6,75
4990M10150	M10	7,80	1,50	8,00	64	23,00	3	8,50
4990M12175	M12	9,00	1,75	10,00	73	26,00	3	10,25



C. CONDITIONS



APPLICATION

M12

M2-M10

SC THREAD MILL R9° - R10° 2XD

Fresa de roscar de metal duro R9° - R10° 2XD

4991

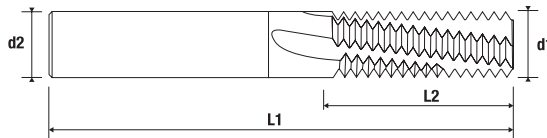

Cod.	M	d1	P	d2	L1	L2	Z	Previous Hole Ø
4991M40070	M4	3,10	0,70	6	55	8	3	3,30
4991M50080	M5	4,00	0,80	6	55	12	3	4,20
4991M60100	M6	4,50	1,00	6	55	12	3	5,00
4991M60100	M7	4,50	1,00	6	55	12	3	6,00
4991M80125	M8	6,00	1,25	6	55	15	3	6,80
4991M12175	M12	8,00	1,75	8	66	20	3	10,20
4991M14200	M14	10,00	2,00	10	80	25	4	12,00
4991M16200	M16	12,00	2,00	12	82	30	4	14,00

Cod.	M	d1	P	d2	L1	L2	Z	Previous Hole Ø
4991MF80100	MF8	6,00	1,00	6	55	15	3	7,00
4991MF10100	MF10	8,00	1,00	8	66	20	3	9,00
	MF12	8,00	1,00	8	66	20	3	11,00
4991MF12125	MF10	8,00	1,25	8	66	20	3	8,80
	MF12	8,00	1,25	8	66	20	3	10,80
4991M10150	M10	8,00	1,50	8	66	20	3	8,50
	MF12	8,00	1,50	8	66	20	3	10,50
4991MF14150	MF14	10,00	1,50	10	80	25	4	13,50
4991MF16150	MF16	12,00	1,50	12	82	30	4	14,50

Double application with the same tool
Doble aplicación con la misma herramienta



C. CONDITIONS



M/MF

SC

RACER

600
1200
N/mm²

45
HRC

55
HRC

GG(G)

INOX

TITAN
INCONEL

ALU
NE

UNI



HA

HPC

HHC



THREAD MILLING PROCESS

Proceso de fresado de machos

4991

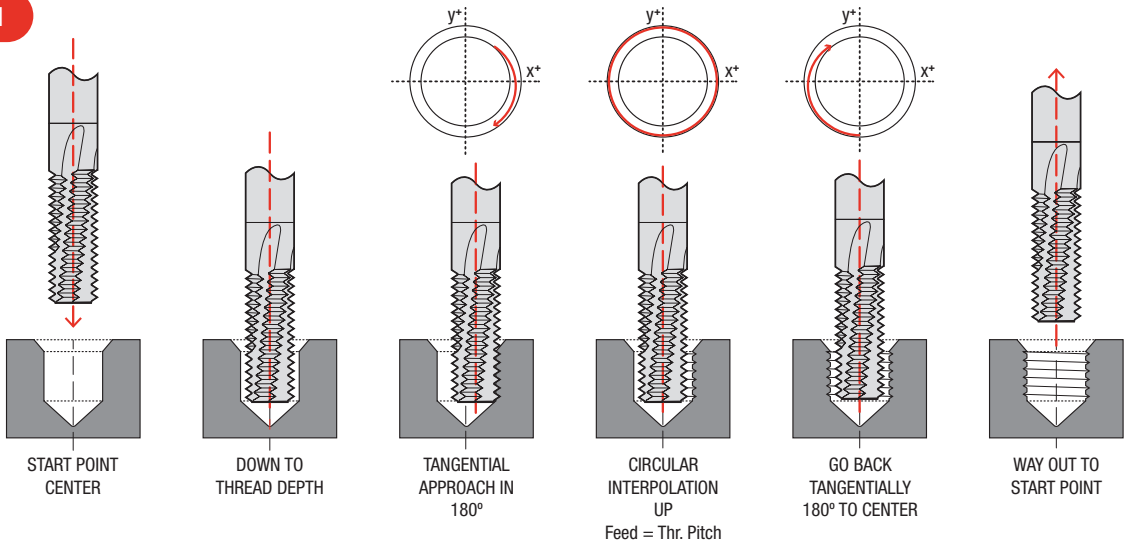

4990

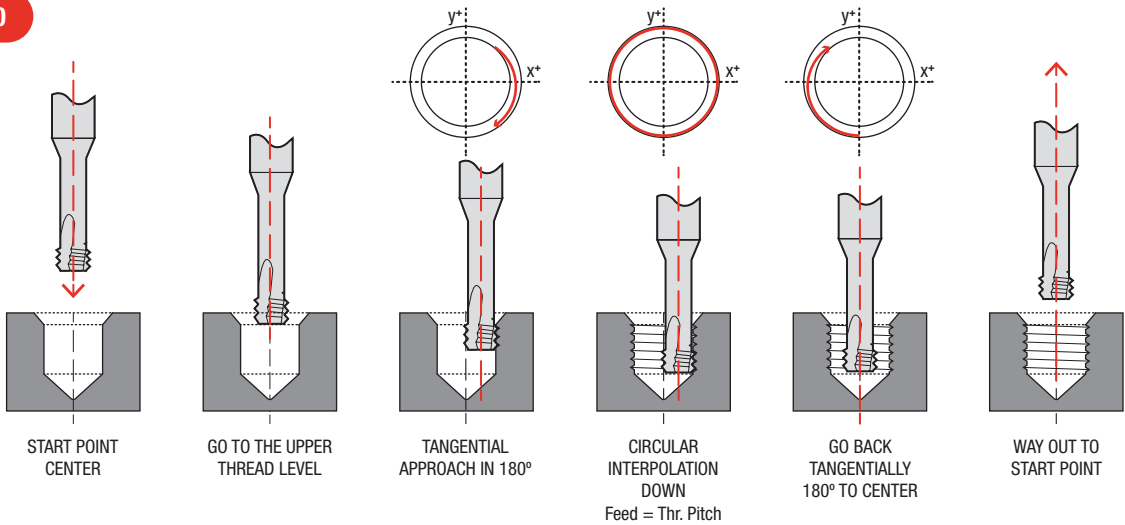

MILL THREADING ADVANTAGES

Thread a wide range of materials

1.2311	316-L
1.2379	St 52
G-AISI 12	GG-25
HARDOX 400	

Thread different diameters with the same thread pitch

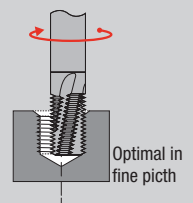
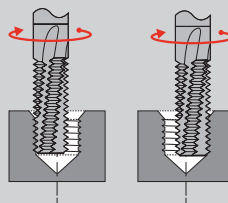
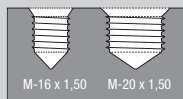

Implementing safety processes for perfect **PRODUCTION** series and **QUALITY**



Use our **online store** and
get **exclusive benefits**.



48.7010

FORMING TAP HSS-E

Macho de laminación HSS-E

M

HSS-E

6HX
TOLERANCE

FORM
C P_x2,5

TIN
Up

600
1200
N/mm²

INOX

GG(G)

TITAN
INCONELL

NI
ALLOYS

UNI



HPC

HSC



DIN
2174

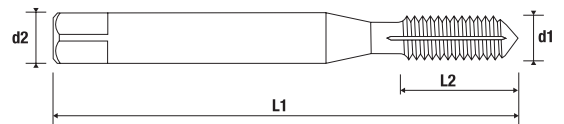

Cod.	M	d1	P	d2	L1	L2	Previous Hole Ø
487010M03	M3	3,00	0,50	3,50	56	10	2,80
487010M04	M4	4,00	0,70	4,50	63	12	3,70
487010M05	M5	5,00	0,80	6,00	70	14	4,65
487010M06	M6	6,00	1,00	6,00	80	16	5,55
487010M08	M8	8,00	1,25	8,00	90	17	7,40
487010M10	M10	10,00	1,50	10,00	100	20	9,30

*Forming taps recommended for the aeronautical industry, for other sectors, consult your application with the Technical Department. / Machos de laminación recomendados para la industria aeronáutica, para otros sectores, consultar su aplicación con el Departamento Técnico.



C. CONDITIONS



APPLICATION

FORMING TAP HSS-E

Macho de laminación HSS-E

48.7016

DIN
2174

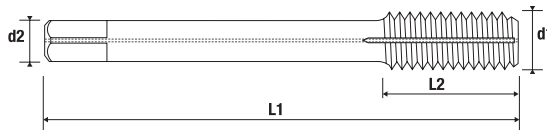

Cod.	M	d1	P	d2	L1	L2	Previous Hole Ø
487016M12	M12	12,00	1,75	9,00	110	24	11,20
487016M14	M14	14,00	2,00	11,00	110	26	13,10
487016M16	M16	16,00	2,00	12,00	110	26	15,10
487016M20	M20	20,00	2,50	16,00	140	32	18,90

*Forming taps recommended for the aeronautical industry, for other sectors, consult your application with the Technical Department. / Machos de laminación recomendados para la industria aeronáutica, para otros sectores, consultar su aplicación con el Departamento Técnico.

M

HSS-E

6HX
TOLERANCE

FORM
C Px2,5



TIN
Up

600
1200
N/mm²

INOX

TITAN
INCONEL

NI
ALLOYS

UNI



HPC

HSC



C. CONDITIONS



40.1040

40.1046

M

HSS-E

6H
TOLERANCE

FORM
B Px4

BLACK
HVA

600
1200
N/mm²

GG(G)

INOX

ALU
NE

UNI



HA



MQL

UNIVERSAL MACHINE TAP HSS-E

Macho de máquina multiuso HSS-E

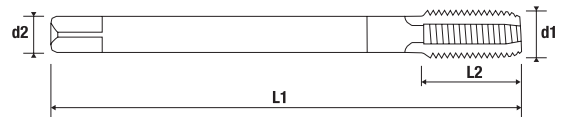
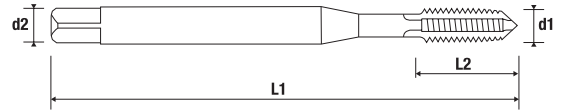

DIN
371 / 376



Cod.	M	d1	P	d2	L1	L2	Previous Hole Ø
401040M03	M3	3,00	0,50	3,50	56	10	2,50
401040M04	M4	4,00	0,70	4,50	63	12	3,20
401040M05	M5	5,00	0,80	6,00	70	14	4,20
401040M06	M6	6,00	1,00	6,00	80	16	5,00
401040M08	M8	8,00	1,25	8,00	90	17	6,80
401040M10	M10	10,00	1,50	10,00	100	20	8,50

Cod.	M	d1	P	d2	L1	L2	Previous Hole Ø
401046M12	M12	12,00	1,75	9,00	110	24	10,20
401046M14	M14	14,00	2,00	11,00	110	26	12,00
401046M16	M16	16,00	2,00	12,00	110	26	14,00
401046M20	M20	20,00	2,50	16,00	140	32	17,50



UNIVERSAL MACHINE TAP HSS-E · TOL. 6G

Macho de máquina multiuso HSS-E · TOL. 6G

40.1640

DIN
371

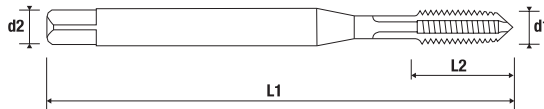

Cod.	M	d1	P	d2	L1	L2	Previous Hole Ø
401640M03	M3	3,00	0,50	3,50	56	10	2,50
401640M04	M4	4,00	0,70	4,50	63	12	3,20
401640M05	M5	5,00	0,80	6,00	70	14	4,20
401640M06	M6	6,00	1,00	6,00	80	16	5,00
401640M08	M8	8,00	1,25	8,00	90	17	6,80
401640M10	M10	10,00	1,50	10,00	100	20	8,50

M

HSS-E

6G

TOLERANCE

FORM
B Px4

BLACK
HVA

600
1200
N/mm²

GG(G)

INOX

ALU
NE

UNI



HA



ML



C. CONDITIONS



40.1140

UNIVERSAL MACHINE TAP HSS-E

Macho de máquina multiuso HSS-E

MF

HSS-E

6H
TOLERANCE

FORM
B Px4

BLACK
HVA

600
1200
N/mm²

GG(G)

INOX

ALU
NE

UNI



HA



MQL

DIN
376

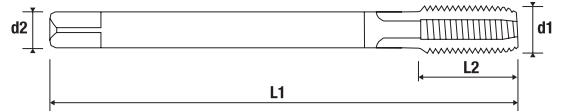

Cod.	M	d1	P	d2	L1	L2	Previous Hole Ø
401140MF405	MF4	4,00	0,50	2,80	63	8	3,50
401140MF505	MF5	5,00	0,50	3,50	70	10	4,50
401140MF6075	MF6	6,00	0,75	4,50	80	13	5,20
401140MF81	MF8	8,00	1,00	6,00	90	16	7,00
401140MF101	MF10	10,00	1,00	7,00	90	16	9,00
401140MF121	MF12	12,00	1,00	9,00	100	20	11,00
401140MF1215	MF12	12,00	1,50	9,00	100	20	10,50
401140MF1415	MF14	14,00	1,50	11,00	100	20	12,50
401140MF1615	MF16	16,00	1,50	12,00	100	22	14,50
401140MF2015	MF20	20,00	1,50	16,00	125	25	18,50



C. CONDITIONS

Helion

UNIVERSAL MACHINE TAP HSS-E

Macho de máquina multiuso HSS-E

40.1240

DIN
5156

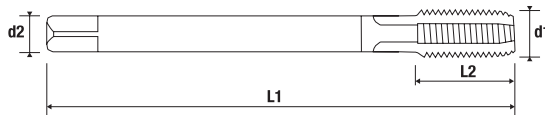

Cod.	Size	d1	P	d2	L1	L2	Previous Hole Ø
401240G18	G1/8	9,73	28	7,00	90	18	8,80
401240G14	G1/4	13,16	19	11,00	100	20	11,80
401240G38	G3/8	16,66	19	12,00	100	22	15,25
401240G12	G1/2	20,96	14	16,00	125	25	19,00
401240G34	G3/4	26,44	14	20,00	140	28	24,50
401240G1	G1"	33,25	11	25,00	160	30	30,75

GAS / BSP

HSS-E BLACK HVA

FORM B Px4 600 1200 N/mm²

GG(G) INOX

ALU NE UNI



MQL



C. CONDITIONS



40.1340

UNIVERSAL MACHINE TAP HSS-E

Macho de máquina multiuso HSS-E

UNF / SAE

HSS-E **2B**
TOLERANCE

FORM **B** Px4 BLACK HVA

600 1200 N/mm² GG(G)

INOX ALU NE

UNI 

 HA

 MQL

DIN 374

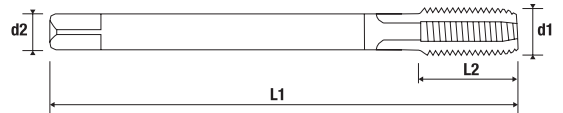

Cod.	Size	d1	P	d2	L1	L2	Previous Hole Ø
401340NF448	UNF4	2,85	48	2,20	56	10	2,40
401340NF640	UNF6	3,51	40	2,50	56	11	2,95
401340NF1032	UNF10	4,83	32	3,50	70	14	4,10
401340NF1428	UNF1/4	6,35	28	4,50	80	16	5,50
401340NF3824	UNF3/8	9,53	24	7,00	90	18	8,50
401340NF5818	UNF5/8	15,88	18	12,00	100	22	14,50

Helion



UNIVERSAL MACHINE TAP HSS-E

Macho de máquina multiuso HSS-E

40.1440

40.1446

DIN
371 / 376

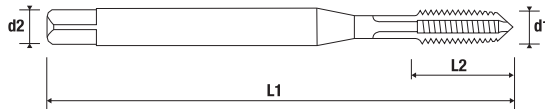

Cod.	Size	d1	P	d2	L1	L2	Previous Hole Ø
401440NC440	UNC4	2,85	40	3,50	56	11	2,35
401440NC632	UNC6	3,51	32	4,00	56	12	2,85
401440NC832	UNC8	4,17	32	4,50	63	12	3,50
401440NC1024	UNC10	4,83	24	6,00	70	14	3,90
401440NC1420	UNC1/4	6,35	20	7,00	80	16	5,10
401440NC51618	UNC5/16	7,94	18	8,00	90	18	6,60
401440NC3816	UNC3/8	9,53	16	10,00	100	20	8,00

Cod.	Size	d1	P	d2	L1	L2	Previous Hole Ø
401446NC71614	UNC7/16	11,11	14	8,00	100	22	9,40
401446NC1213	UNC1/2	12,70	13	9,00	110	25	10,80
401446NC5811	UNC5/8	15,88	11	12,00	110	30	13,50
401446NC3410	UNC3/4	19,05	10	14,00	125	33	16,50

UNC

HSS-E

2B
TOLERANCE

FORM
B Px4

BLACK
HVA

600
1200
N/mm²

GG(G)

INOX

ALU
NE

UNI



HA



MQL



C. CONDITIONS
40.1440



C. CONDITIONS
40.1446



41.6040

UNIVERSAL MACHINE TAP PERFORMANCE HSS-E-PM

Macho de máquina multiuso de alto rendimiento HSS-E-PM

M

HSS-E-PM

6H
TOLERANCE

FORM
B Px4

TIN
Up

600
1200
N/mm²

GG(G)

INOX

UNI



HA

HPC

HSC



ML



DIN
371

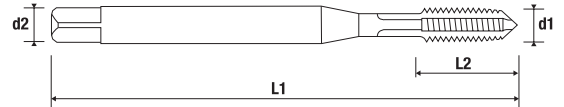

Cod.	M	d1	P	d2	L1	L2	Previous Hole Ø
416040M02	M2	2,00	0,40	2,80	45	8	1,60
416040M03	M3	3,00	0,50	3,50	56	10	2,50
416040M04	M4	4,00	0,70	4,50	63	12	3,30
416040M05	M5	5,00	0,80	6,00	70	14	4,20
416040M06	M6	6,00	1,00	6,00	80	16	5,00
416040M08	M8	8,00	1,25	8,00	90	17	6,80
416040M10	M10	10,00	1,50	10,00	100	20	8,50



C. CONDITIONS



APPLICATION

UNIVERSAL MACHINE TAP PERFORMANCE HSS-E-PM

Macho de máquina multiuso de alto rendimiento HSS-E-PM

41.6046

DIN
376

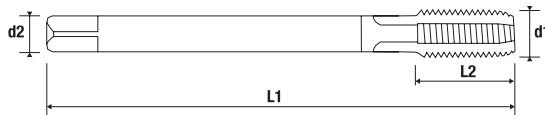

Cod.	M	d1	P	d2	L1	L2	Previous Hole Ø
416046M12	M12	12,00	1,75	9,00	110	24	10,20
416046M14	M14	14,00	2,00	11,00	110	26	12,00
416046M16	M16	16,00	2,00	12,00	110	26	14,00
416046M18	M18	18,00	2,50	14,00	125	30	15,50
416046M20	M20	20,00	2,50	16,00	140	32	17,50

M

HSS-E-PM

6H
TOLERANCE

FORM
B Px4

TIN
Up

600
1200
N/mm²

GG(G)

INOX

UNI



HA
HPC

HSC



MQL



C. CONDITIONS



45.5040

HIGH PERFORMANCE MACHINE TAP HSS-E

Macho de máquina de alto rendimiento HSS-E

M

HSS-E

6HX
TOLERANCE

FORM
B Px4

DSC

600
1200
N/mm²

INOX

GG(G)

TITAN
INCONELL



HA

HPC

HSC



**DIN
371**

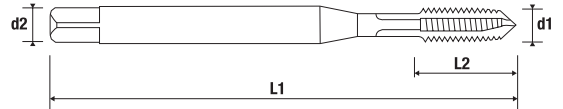

Cod.	M	d1	P	d2	L1	L2	Previous Hole Ø
455040M02	M2	2,00	0,40	2,80	45	8	1,60
455040M025	M2,5	2,50	0,45	2,80	50	9	2,05
455040M03	M3	3,00	0,50	3,50	56	10	2,50
455040M04	M4	4,00	0,70	4,50	63	12	3,30
455040M05	M5	5,00	0,80	6,00	70	14	4,20
455040M06	M6	6,00	1,00	6,00	80	16	5,00
455040M08	M8	8,00	1,25	8,00	90	17	6,80
455040M10	M10	10,00	1,50	10,00	100	20	8,50



C. CONDITIONS

HIGH PERFORMANCE MACHINE TAP HSS-E

Macho de máquina de alto rendimiento HSS-E

45.5046

DIN
376

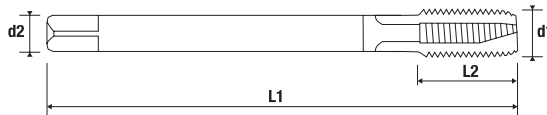

Cod.	M	d1	P	d2	L1	L2	Previous Hole Ø
455046M12	M12	12,00	1,75	9,00	110	24	10,20
455046M14	M14	14,00	2,00	11,00	110	26	12,00
455046M16	M16	16,00	2,00	12,00	110	26	14,00
455046M18	M18	18,00	2,50	14,00	125	30	15,50
455046M20	M20	20,00	2,50	16,00	140	32	17,50
455046M24	M24	24,00	3,00	18,00	160	36	21,00
455046M30	M30	30,00	3,50	22,00	180	40	26,50

M

HSS-E 6HX
TOLERANCE

FORM B Px4 DSC

600 1200 N/mm² INOX

GG(G) TITAN INCONEL



HA HPC

HSC



C. CONDITIONS



45.5144

HIGH PERFORMANCE MACHINE TAP HSS-E

Macho de máquina de alto rendimiento HSS-E

MF

HSS-E

6HX
TOLERANCE

FORM
B Px4

DSC

600
1200
N/mm²

INOX

GG(G)

TITAN
INCONELL



HA

HPC

HSC



MQL



**DIN
374**

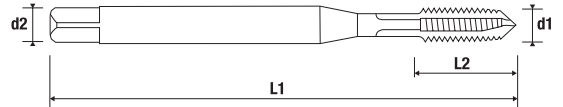

Cod.	M	d1	P	d2	L1	L2	Previous Hole Ø
455144MF6075	MF6	6,00	0,75	4,50	80	13	5,20
455144MF8075	MF8	8,00	0,75	6,00	80	14	7,20
455144MF81	MF8	8,00	1,00	6,00	90	16	7,00
455144MF101	MF10	10,00	1,00	7,00	90	16	9,00
455144MF10125	MF10	10,00	1,25	7,00	100	20	8,80
455144MF121	MF12	12,00	1,00	9,00	100	20	11,00
455144MF12125	MF12	12,00	1,25	9,00	100	20	10,80
455144MF1215	MF12	12,00	1,50	9,00	100	20	10,50
455144MF1415	MF14	14,00	1,50	11,00	100	20	12,50
455144MF1615	MF16	16,00	1,50	12,00	100	22	14,50
455144MF1815	MF18	18,00	1,50	14,00	110	25	16,50
455144MF2015	MF20	20,00	1,50	16,00	125	25	18,50
455144MF2415	MF24	24,00	1,50	18,00	140	28	22,50



C. CONDITIONS

HIGH PERFORMANCE MACHINE TAP HSS-E

Macho de máquina de alto rendimiento HSS-E

45.5245

DIN
5156

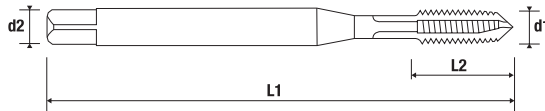

Cod.	Size	d1	P	d2	L1	L2	Prev. Hole Ø
455245G116	GAS1/16	7,72	28	6,00	90	18	6,80
455245G18	GAS1/8	9,73	28	7,00	90	18	8,80
455245G14	GAS1/4	13,16	19	11,00	100	20	11,80
455245G38	GAS3/8	16,66	19	12,00	100	22	15,25
455245G12	GAS1/2	20,96	14	16,00	125	25	19,00
455245G58	GAS5/8	22,91	14	18,00	125	25	21,00
455245G34	GAS3/4	26,44	14	20,00	140	28	24,50
455245G78	GAS7/8	30,20	14	22,00	150	28	28,25
455245G1	GAS1"	33,25	11	25,00	160	30	30,75

GAS / BSP

HSS-E

FORM
B Px4

DSC

600
1200
N/mm²

INOX

GG(G)

ALU
NE

TITAN
INCONEL



HA

HPC

HSC



MQL



C. CONDITIONS

44.0040

MACHINE TAP FOR ALUMINIUM HSS-E

Macho de máquina especial aluminio HSS-E

M

HSS-E

6H
TOLERANCE

FORM
B
Px4

BRIGHT

ALU
NE

PLASTIC

GFK
CFK



HA

HPC

HSC



MQL



DIN
371

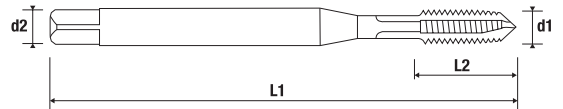

Cod.	M	d1	P	d2	L1	L2	Previous Hole Ø
440040M03	M3	3,00	0,50	3,50	56	10	2,50
440040M04	M4	4,00	0,70	4,50	63	12	3,30
440040M05	M5	5,00	0,80	6,00	70	14	4,20
440040M06	M6	6,00	1,00	6,00	80	16	5,00
440040M08	M8	8,00	1,25	8,00	90	17	6,80
440040M10	M10	10,00	1,50	10,00	100	20	8,50



C. CONDITIONS

MACHINE TAP FOR ALUMINIUM HSS-E

Macho de máquina especial aluminio HSS-E

44.0046

DIN
376

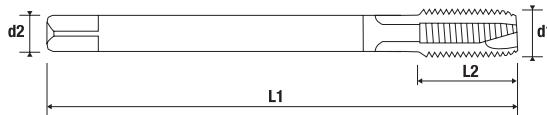

Cod.	M	d1	P	d2	L1	L2	Previous Hole Ø
440046M12	M12	12,00	1,75	9,00	110	24	10,20
440046M16	M16	16,00	2,00	12,00	110	26	14,00
440046M20	M20	20,00	2,50	16,00	140	32	17,50

M

HSS-E

6H
TOLERANCE

FORM
B_{Px4}

BRIGHT

ALU
NE

PLASTIC

GFK
CFK



HA

HPC

HSC



MQL



C. CONDITIONS



43.2810

43.2816

M

HSS-E-PM

6HX
TOLERANCE

FORM
C Px2,5



SHARK

600
1200
N/mm²

GG(G)

SI ≥ 7%



HA

HPC



HIGH PERFORMANCE MACHINE TAP HSS-E-PM

Macho de máquina de alto rendimiento HSS-E-PM

DIN
371

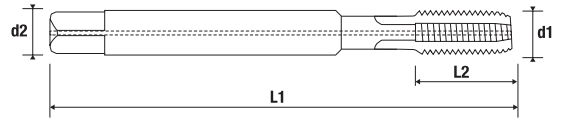

DIN
376

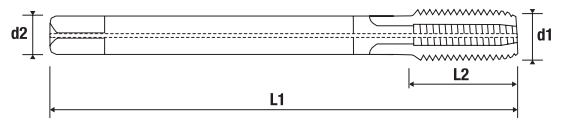

Cod.	M	d1	P	d2	L1	L2	Previous Hole Ø
432810M05	M5	5,00	0,80	6,00	70	14	4,20
432810M06	M6	6,00	1,00	6,00	80	16	5,00
432810M08	M8	8,00	1,25	8,00	90	17	6,80
432810M10	M10	10,00	1,50	10,00	100	20	8,50

Cod.	M	d1	P	d2	L1	L2	Previous Hole Ø
432816M10	M10	10,00	1,50	7,00	100	20	8,50
432816M12	M12	12,00	1,75	9,00	110	24	10,20
432816M14	M14	14,00	2,00	11,00	110	26	12,00



HIGH PERFORMANCE MACHINE TAP HSS-E-PM

Macho de máquina de alto rendimiento HSS-E-PM

43.2117

DIN
374

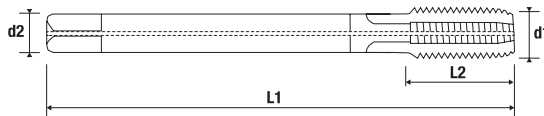

Cod.	M	d1	P	d2	L1	L2	Previous Hole Ø
432117MF05050	MF5	5,00	0,50	3,50	70	10	4,50
432117MF06050	MF6	6,00	0,50	4,50	80	13	5,50
432117MF06075	MF6	6,00	0,75	4,50	80	13	5,20
432117MF08075	MF8	8,00	0,75	6,00	80	14	7,20
432117MF08100	MF8	8,00	1,00	6,00	90	16	7,00
432117MF10100	MF10	10,00	1,00	7,00	90	16	9,00
432117MF10125	MF10	10,00	1,25	7,00	100	20	9,30
432117MF12100	MF12	12,00	1,00	9,00	100	20	11,00
432117MF12125	MF12	12,00	1,25	9,00	100	20	10,80
432117MF12150	MF12	12,00	1,50	9,00	100	20	10,50
432117MF14150	MF14	14,00	1,50	11,00	100	20	12,50
432117MF16150	MF16	16,00	1,50	12,00	100	22	14,50

MF

HSS-E-PM

6HX
TOLERANCE

FORM
C P_x2,5



SHARK

600
1200
N/mm²

GG(G)

SI ≥ 7%



HPC



C. CONDITIONS



46.4040

HIGH PERFORMANCE MACHINE TAP HSS-E-PM

Macho de máquina de alto rendimiento HSS-E-PM

M

HSS-E-PM

6HX
TOLERANCE

FORM B
Px4

SHARK

TITAN
INCONELL

NI
ALLOYS

GG(G)



HPC



DIN 371

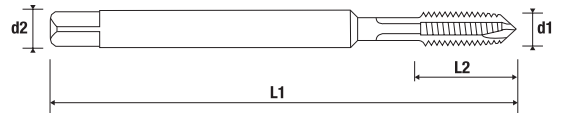

Cod.	M	d1	P	d2	L1	L2	Previous Hole Ø
464040M03	M3	3,00	0,50	3,50	56	10	2,50
464040M04	M4	4,00	0,70	4,50	63	12	3,30
464040M05	M5	5,00	0,80	6,00	70	14	4,20
464040M06	M6	6,00	1,00	6,00	80	16	5,00
464040M08	M8	8,00	1,25	8,00	90	17	6,80
464040M10	M10	10,00	1,50	10,00	100	20	8,50



Helion

HIGH PERFORMANCE MACHINE TAP HSS-E-PM

Macho de máquina de alto rendimiento HSS-E-PM

46.4046

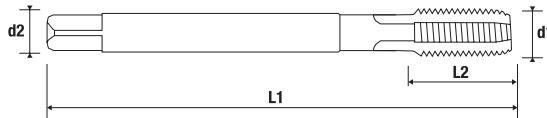

Cod.	M	d1	P	d2	L1	L2	Previous Hole Ø
464046M12	M12	12,00	1,75	9,00	110	24	10,20
464046M16	M16	16,00	2,00	12,00	110	26	14,00



C. CONDITIONS

43.2010

HIGH PERFORMANCE MACHINE TAP HSS-E-PM

Macho de máquina de alto rendimiento HSS-E-PM

M

HSS-E-PM

6HX
TOLERANCE

FORM
D Px3

SHARK

42-54
HRC



HA

HHC

HPC



DIN
371 / 376

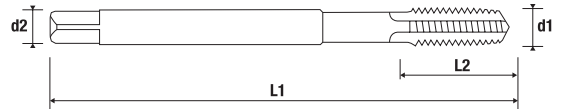

Cod.	M	d1	P	d2	L1	L2	Previous Hole Ø
432010M03	M3	3,00	0,50	3,50	56	10	2,60
432010M04	M4	4,00	0,70	4,50	63	12	3,40
432010M05	M5	5,00	0,80	6,00	70	14	4,30
432010M06	M6	6,00	1,00	6,00	80	16	5,10
432010M08	M8	8,00	1,25	8,00	90	17	6,90
432010M10	M10	10,00	1,50	10,00	100	20	8,60
432010M12	M12	12,00	1,75	12,00	110	24	10,40
432010M14	M14	14,00	2,00	14,00	110	26	12,00
432010M16	M16	16,00	2,00	16,00	110	26	14,10



C. CONDITIONS

SC MACHINE TAP HARDENED STEELS

Macho de máquina de metal duro para aceros templados

47.9010

DIN
371

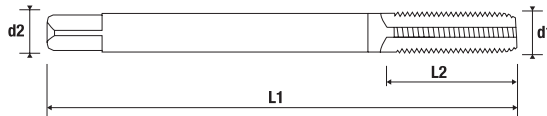

Cod.	M	d1	P	d2	L1	L2	Previous Hole Ø
479010M03	M3	3,00	0,50	3,50	56	12	2,60
479010M04	M4	4,00	0,70	4,50	63	14	3,40
479010M05	M5	5,00	0,80	6,00	70	17	4,30
479010M06	M6	6,00	1,00	6,00	80	20	5,10
479010M08	M8	8,00	1,25	8,00	90	20	6,90
479010M10	M10	10,00	1,50	10,00	100	24	8,60
479010M12	M12	12,00	1,75	12,00	110	28	10,40
479010M16	M16	16,00	2,00	16,00	110	40	14,10

48-63 HRc / VC= 1-2 m/min

Use drill bit 62.6000 for the holes prior to threading, according to the recommended diameters for each thread

Utilice la broca 62.600 para los agujeros previos de acuerdo con los diámetros recomendados para cada rosca.

M

SC **6H**
TOLERANCE

FORM D Px3 **48-63**
HRC

SHARK

HA **HHC**

HPC



C. CONDITIONS



40.1060

UNIVERSAL MACHINE TAP HSS-E

Macho de máquina multiuso HSS-E

M

HSS-E

6H
TOLERANCE

FORM
C P_{x2,5}

BLACK
HVA

600
1200
N/mm²

GG(G)

INOX

ALU
NE

UNI



ML



DIN
371

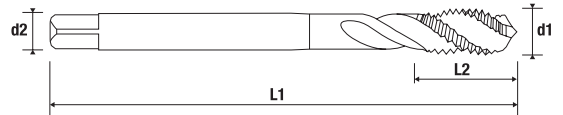

Cod.	M	d1	P	d2	L1	L2	Previous Hole Ø
401060M03	M3	3	0,50	3,50	56	6	2,50
401060M04	M4	4	0,70	4,50	63	8	3,20
401060M05	M5	5	0,80	6,00	70	9	4,20
401060M06	M6	6	1,00	6,00	80	11	5,00
401060M08	M8	8	1,25	8,00	90	14	6,80
401060M10	M10	10	1,50	10,00	100	16	8,50



C. CONDITIONS



APPLICATION

UNIVERSAL MACHINE TAP HSS-E

Macho de máquina multiuso HSS-E

40.1066

DIN
376

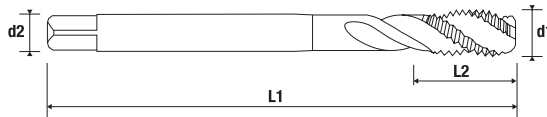

Cod.	M	d1	P	d2	L1	L2	Previous Hole Ø
401066M12	M12	12,00	1,75	9,00	110	19	10,20
401066M16	M16	16,00	2,00	12,00	110	20	14,00
401066M20	M20	20,00	2,50	16,00	140	25	17,50
401066M24	M24	24,00	3,00	18,00	160	36	21,00

M

HSS-E

6H
TOLERANCE

FORM
C_{Px2,5}

BLACK
HVA

600
1200
N/mm²

GG(G)

INOX

ALU
NE

UNI



MQL



C. CONDITIONS



40.1050

UNIVERSAL MACHINE TAP HSS-E

Macho de máquina multiuso HSS-E

M

HSS-E

6H
TOLERANCE

FORM
E
Px1,5

BLACK
HVA

600
1200
N/mm²

GG(G)

INOX

ALU
NE

UNI



MQL



DIN
371

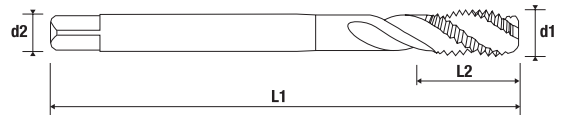

Cod.	M	d1	P	d2	L1	L2	Previous Hole Ø
401050M03	M3	3,00	0,50	3,50	56	6,00	2,50
401050M04	M4	4,00	0,70	4,50	63	7,50	3,30
401050M05	M5	5,00	0,80	6,00	70	8,50	4,20
401050M06	M6	6,00	1,00	6,00	80	11,00	5,00
401050M08	M8	8,00	1,25	8,00	90	14,00	6,80
401050M10	M10	10,00	1,50	10,00	100	16,00	8,50



FORM E WITH
SHORT ENTRY

FORMA E CON
ENTRADA
CORTA



C. CONDITIONS



Helion

UNIVERSAL MACHINE TAP HSS-E · TOL. 6G

Macho de máquina multiuso HSS-E · TOL. 6G

40.1660

DIN
371

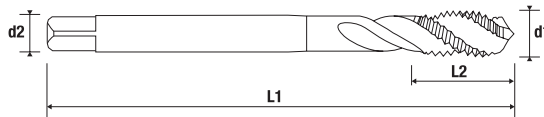

Cod.	M	d1	P	d2	L1	L2	Previous Hole Ø
401660M03	M3	3,00	0,50	3,50	56	6,00	2,50
401660M04	M4	4,00	0,70	4,50	63	8,00	3,20
401660M05	M5	5,00	0,80	6,00	70	9,00	4,20
401660M06	M6	6,00	1,00	6,00	80	11,00	5,00
401660M08	M8	8,00	1,25	8,00	90	14,00	6,80
401660M10	M10	10,00	1,50	10,00	100	16,00	8,50

M

HSS-E

6G
TOLERANCE

FORM
C P_{x2,5}

BLACK
HVA

600
1200
N/mm²

GG(G)

INOX

ALU
NE

UNI



MQL



C. CONDITIONS



40.1160

UNIVERSAL MACHINE TAP HSS-E

Macho de máquina multiuso HSS-E

MF

HSS-E

6H
TOLERANCE

FORM
C
Px2,5

BLACK
HVA

600
1200
N/mm²

GG(G)

INOX

ALU
NE

UNI



HA



MQL



DIN
374

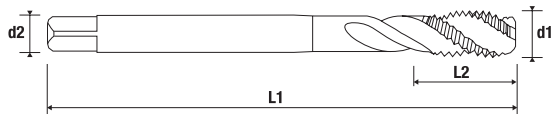

Cod.	M	d1	P	d2	L1	L2	Previous Hole Ø
401160MF405	MF4	4,00	0,50	2,80	63	5,00	3,50
401160MF505	MF5	5,00	0,50	3,50	70	5,00	4,50
401160MF6075	MF6	6,00	0,75	4,50	80	8,00	5,25
401160MF81	MF8	8,00	1,00	6,00	90	11,00	7,00
401160MF101	MF10	10,00	1,00	7,00	90	11,00	9,00
401160MF10125	MF10	10,00	1,25	7,00	100	14,00	8,80
401160MF121	MF12	12,00	1,00	9,00	100	11,00	11,00
401160MF12125	MF12	12,00	1,25	9,00	100	16,00	10,80
401160MF1215	MF12	12,00	1,50	9,00	100	16,00	10,50
401160MF141	MF14	14,00	1,00	11,00	100	11,00	13,00
401160MF1415	MF14	14,00	1,50	11,00	100	15,00	12,50
401160MF161	MF16	16,00	1,00	12,00	100	11,00	15,00
401160MF1615	MF16	16,00	1,50	12,00	100	15,00	14,50
401160MF2015	MF20	20,00	1,50	16,00	125	16,00	18,50



C. CONDITIONS

UNIVERSAL MACHINE TAP HSS-E

Macho de máquina multiuso HSS-E

40.1260

DIN
5156

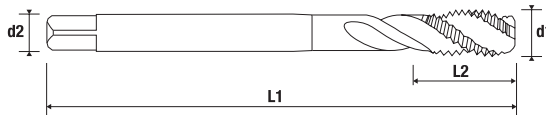

Cod.	Size	d1	P	d2	L1	L2	Previous Hole Ø
401260G18	GAS1/8	9,73	28	7,00	90	11,00	8,80
401260G14	GAS1/4	13,16	19	11,00	100	14,00	11,80
401260G38	GAS3/8	16,66	19	12,00	100	14,00	15,25
401260G12	GAS1/2	20,96	14	16,00	125	18,00	19,00
401260G34	GAS3/4	26,44	14	20,00	140	20,00	24,50
401260G1	GAS1"	33,25	11	25,00	160	24,00	30,75

GAS / BSP

HSS-E FORM C Px2,5

BLACK HVA 600 1200 N/mm²

GG(G) INOX

ALU NE UNI



C. CONDITIONS



40.1360

UNIVERSAL MACHINE TAP HSS-E

Macho de máquina multiuso HSS-E

UNF / SAE

HSS-E **2B**
TOLERANCE

FORM **C**
Px2,5 BLACK HVA

600 1200
N/mm² GG(G)

INOX ALU
NE

UNI

HA

SQL

DIN
374

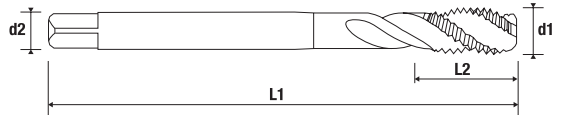

Cod.	Size	d1	P	d2	L1	L2	Previous Hole Ø
401360NF448	UNF4	2,85	48,00	2,20	56	6,00	2,40
401360NF640	UNF6	3,51	40,00	2,50	56	7,00	2,95
401360NF1032	UNF10	4,83	32,00	3,50	70	9,00	4,10
401360NF1428	UNF1/4	6,35	28,00	4,50	80	9,00	5,50
401360NF3824	UNF3/8	9,53	24,00	7,00	90	11,00	8,50
401360NF5818	UNF5/8	15,88	18,00	12,00	100	15,00	14,50



C. CONDITIONS

UNIVERSAL MACHINE TAP HSS-E

Macho de máquina multiuso HSS-E

40.1460

40.1466

DIN
371 / 376

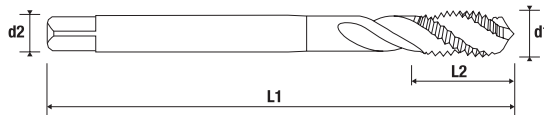

Cod.	Size	d1	P	d2	L1	L2	Previous Hole Ø
401460NC440	UNC4	2,85	40,00	3,50	56	7,00	2,35
401460NC632	UNC6	3,51	32,00	4,00	56	8,00	2,85
401460NC832	UNC8	4,17	32,00	4,50	63	8,00	3,50
401460NC1024	UNC10	4,83	24,00	6,00	70	11,00	3,90
401460NC1420	UNC1/4	6,35	20,00	7,00	80	13,00	5,10
401460NC51618	UNC5/16	7,94	18,00	8,00	90	14,00	6,60
401460NC3816	UNC3/8	9,53	16,00	10,00	100	16,00	8,00

Cod.	Size	d1	P	d2	L1	L2	Previous Hole Ø
401466NC71614	UNC7/16	11,11	14,00	8,00	100	18,00	9,40
401466NC1213	UNC1/2	12,7	13,00	9,00	110	20,00	10,80
401466NC5811	UNC5/8	15,88	11,00	12,00	110	24,00	13,50
401466NC3410	UNC3/4	19,05	10,00	14,00	125	25,00	16,50

UNC

HSS-E

2B
TOLERANCE

FORM
C_{Px2,5}

BLACK
HVA

600
1200
N/mm²

GG(G)

INOX

ALU
NE

UNI



MQL



C. CONDITIONS
40.1460



C. CONDITIONS
40.1466



40.7068

UNIVERSAL MACHINE TAP LONG HSS-E

Macho de máquina multiuso largo HSS-E

M

HSS-E **6HX**
TOLERANCE

FORM **TIN**
C Px2,5 Up

600
1200
N/mm² **GG(G)**

INOX **UNI**

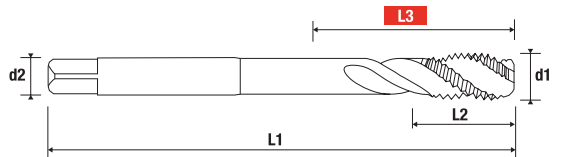

Cod.	M	d1	P	d2	L1	L2	L3	Previous Hole Ø
407068M03	M3	3,00	0,50	3,50	112	6,00	18,00	2,50
407068M04	M4	4,00	0,70	2,80	112	8,00	77,00	3,20
407068M05	M5	5,00	0,80	3,50	125	9,00	90,00	4,20
407068M06	M6	6,00	1,00	4,50	125	11,00	90,00	5,00
407068M08	M8	8,00	1,25	6,00	140	14,00	97,00	6,80
407068M10	M10	10,00	1,50	7,00	160	16,00	117,00	8,50
407068M12	M12	12,00	1,75	9,00	180	19,00	133,00	10,20
407068M16	M16	16,00	2,00	12,00	220	20,00	168,00	14,00
407068M20	M20	20,00	2,50	16,00	280	25,00	225,00	17,50

* Special long
* Largo especial



C. CONDITIONS



VISIT OUR INTERNATIONAL EXHIBITIONS

Innovation, service and superior quality are our seal of guarantee.

Visit us at our fair stand and let **one of our technical professionals** advise you on the most suitable tools for your machining processes.



You will find the date of our
international fairs on our website

40.7060

UNIVERSAL MACHINE TAP HSS-E

Macho de máquina multiuso HSS-E

M

HSS-E

6H
TOLERANCE

FORM
C P_x2,5

TIN
Up

600
1200
N/mm²

GG(G)

INOX

UNI



DIN
371

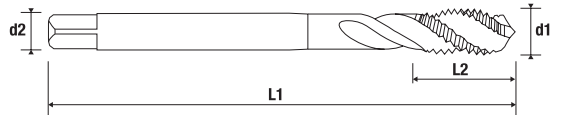

Cod.	M	d1	P	d2	L1	L2	Previous Hole Ø
407060M02	M2	2,00	0,40	2,80	45	5,00	1,60
407060M03	M3	3,00	0,50	3,50	56	6,00	2,50
407060M04	M4	4,00	0,70	4,50	63	8,00	3,20
407060M05	M5	5,00	0,80	6,00	70	9,00	4,20
407060M06	M6	6,00	1,00	6,00	80	11,00	5,00
407060M08	M8	8,00	1,25	8,00	90	14,00	6,80
407060M10	M10	10,00	1,50	10,00	100	16,00	8,50



C. CONDITIONS

UNIVERSAL MACHINE TAP HSS-E

Macho de máquina multiuso HSS-E

40.7066

DIN
376

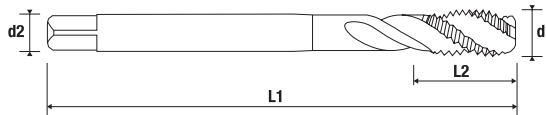

Cod.	M	d1	P	d2	L1	L2	Previous Hole Ø
407066M12	M12	12,00	1,75	9,00	110	19,00	10,20
407066M14	M14	14,00	2,00	11,00	110	20,00	12,00
407066M16	M16	16,00	2,00	12,00	110	20,00	14,00
407066M20	M20	20,00	2,50	16,00	140	25,00	17,50
407066M24	M24	24,00	3,00	18,00	160	30,00	21,00

M

HSS-E

6HX
TOLERANCE

FORM
C_{Px2,5}

TIN
Up

600
1200
N/mm²

GG(G)

INOX

UNI



HPC



MQL



C. CONDITIONS



41.6050 41.6056

M

HSS-E-PM

6H
TOLERANCE

FORM
C P_x2,5

TIN
Up

600
1200
N/mm²

GG(G)

INOX

UNI

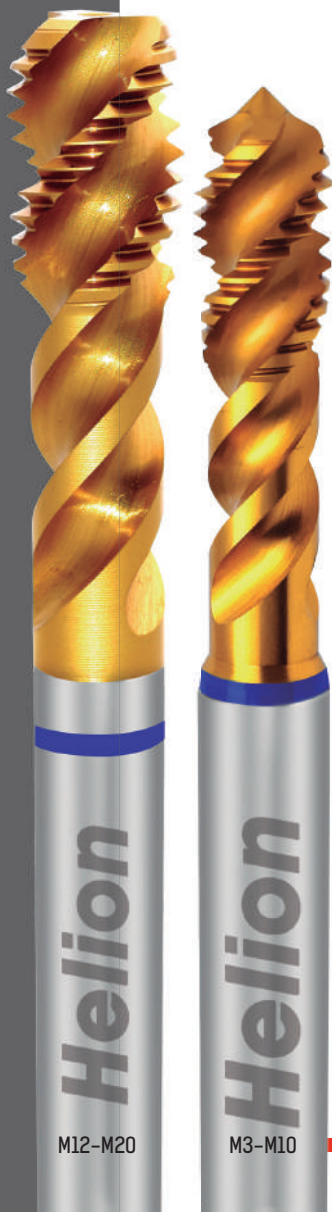

M12-M20

M3-M10

UNIVERSAL MACHINE TAP PERFORMANCE HSS-E-PM

Macho de máquina multiuso de alto rendimiento HSS-E-PM

DIN
371 / 376

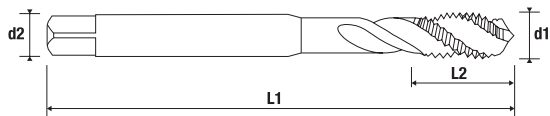

Cod.	M	d1	P	d2	L1	L2	Previous Hole Ø
416050M03	M3	3,00	0,50	3,50	56	6,00	2,50
416050M04	M4	4,00	0,70	4,50	63	8,00	3,20
416050M05	M5	5,00	0,80	6,00	70	9,00	4,20
416050M06	M6	6,00	1,00	6,00	80	11,00	5,00
416050M08	M8	8,00	1,25	8,00	90	14,00	6,80
416050M10	M10	10,00	1,50	10,00	100	16,00	8,50

* Helix 50° / * Hélice 50°

Cod.	M	d1	P	d2	L1	L2	Previous Hole Ø
416056M12	M12	12,00	1,75	9,00	110	19,00	10,20
416056M14	M14	14,00	2,00	11,00	110	20,00	12,00
416056M16	M16	16,00	2,00	12,00	110	20,00	14,00
416056M20	M20	20,00	2,50	16,00	140	25,00	17,50

**Especially for rigid threading with synchronized feed

** Especial para roscado rígido con avance sincronizado



C. CONDITIONS
41.6050



C. CONDITIONS
41.6056

HIGH PERFORMANCE MACHINE TAP HSS-E

Macho de máquina de alto rendimiento HSS-E

45.4060

45.4066

DIN
371

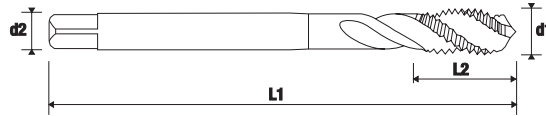

DIN
376

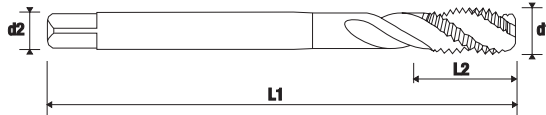

Cod.	M	d1	P	d2	L1	L2	Previous Hole Ø
454060M02	M2	2,00	0,40	2,80	45	4,50	1,60
454060M03	M3	3,00	0,50	3,50	56	6,00	2,50
454060M04	M4	4,00	0,70	4,50	63	7,50	3,30
454060M05	M5	5,00	0,80	6,00	70	8,50	4,20
454060M06	M6	6,00	1,00	6,00	80	11,00	5,00
454060M08	M8	8,00	1,25	8,00	90	14,00	6,80
454060M10	M10	10,00	1,50	10,00	100	30,00	8,50

Cod.	M	d1	P	d2	L1	L2	Previous Hole Ø
454066M12	M12	12,00	1,75	9,00	110	19	10,20
454066M14	M14	14,00	2,00	11,00	110	20	12,00
454066M16	M16	16,00	2,00	12,00	110	20	14,00
454066M18	M18	18,00	2,50	14,00	125	25	15,50
454066M20	M20	20,00	2,50	16,00	140	25	17,50
454066M24	M24	24,00	3,00	18,00	160	30	21,00
454066M30	M30	30,00	3,50	22,00	180	35	26,50



C. CONDITIONS
45.4060



APPLICATION
45.4060



C. CONDITIONS
45.4066



M2-M10

M12-M30

M

HSS-E

6HX

TOLERANCE

FORM C

Px2,5

RACER

600

1200

N/mm²

INOX

GG(G)

ALU
NE

TITAN
INCONEL



HA
HPC

HSC



MQL



45.4164

HIGH PERFORMANCE MACHINE TAP HSS-E

Macho de máquina de alto rendimiento HSS-E

MF

HSS-E

6HX
TOLERANCE

FORM
C Px2,5

RACER

600
1200
N/mm²

INOX

GG(G)

**ALU
NE**

TITAN
INCONELL



HA

HPC

HSC



MQL



**DIN
374**

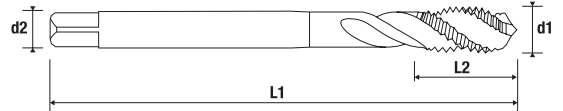

Cod.	M	d1	P	d2	L1	L2	Previous Hole Ø
454164MF6075	MF6	6,00	0,75	4,50	80	8	5,20
454164MF8075	MF8	8,00	0,75	6,00	80	8	7,20
454164MF81	MF8	8,00	1,00	6,00	90	11	7,00
454164MF101	MF10	10,00	1,00	7,00	90	11	9,00
454164MF10125	MF10	10,00	1,25	7,00	100	14	8,80
454164MF121	MF12	12,00	1,00	9,00	100	11	11,00
454164MF12125	MF12	12,00	1,25	9,00	100	16	10,80
454164MF1215	MF12	12,00	1,50	9,00	100	16	10,50
454164MF1415	MF14	14,00	1,50	11,00	100	15	12,50
454164MF1615	MF16	16,00	1,50	12,00	100	15	14,50
454164MF1815	MF18	18,00	1,50	14,00	110	16	16,50
454164MF2015	MF20	20,00	1,50	16,00	125	16	18,50
454164MF2415	MF24	24,00	1,50	18,00	140	16	22,50



C. CONDITIONS

Helion

HIGH PERFORMANCE MACHINE TAP HSS-E

Macho de máquina de alto rendimiento HSS-E

45.3265

DIN
5156

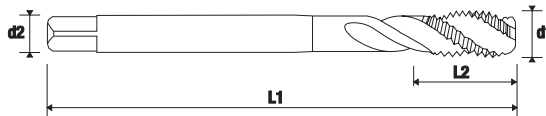

Cod.	Size	d1	P	d2	L1	L2	Previous Hole Ø
453265G116	GAS1/16	7,72	28,00	6,00	90	11	6,80
453265G18	GAS1/8	9,73	28,00	7,00	90	11	8,80
453265G14	GAS1/4	13,16	19,00	11,00	100	14	11,80
453265G38	GAS3/8	16,66	19,00	12,00	100	14	15,25
453265G12	GAS1/2	20,96	14,00	16,00	125	18	19,00
453265G58	GAS5/8	22,91	14,00	18,00	125	18	21,00
453265G34	GAS3/4	26,44	14,00	20,00	140	20	24,50
453265G78	GAS7/8	30,20	14,00	22,00	150	22	28,25
453265G1	GAS1"	33,25	11	25,00	160	24	30,75

GAS / BSP

HSS-E

6HX
TOLERANCE

FORM
C Px2,5

RACER

600
1200
N/mm²

INOX

GG(G)

**ALU
NE**

TITAN
INCONELL



HA

HPC

HSC



MQL



C. CONDITIONS



44.0060

MACHINE TAP FOR ALUMINIUM HSS-E

Macho de máquina especial aluminio HSS-E

M

HSS-E

6H
TOLERANCE

FORM
C
Px2,5

BRIGHT

ALU
NE

PLASTIC

GFK
CFK



DIN
371

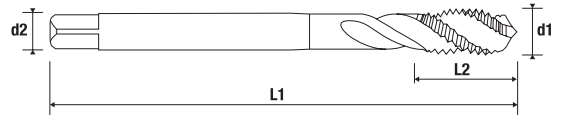

Cod.	M	d1	P	d2	L1	L2	Previous Hole Ø
440060M03	M3	3,00	0,50	3,50	56	6	2,50
440060M04	M4	4,00	0,70	4,50	63	8	3,30
440060M05	M5	5,00	0,80	6,00	70	9	4,20
440060M06	M6	6,00	1,00	6,00	80	11	5,00
440060M08	M8	8,00	1,25	8,00	90	14	6,80
440060M10	M10	10,00	1,50	10,00	100	16	8,50



C. CONDITIONS

MACHINE TAP FOR ALUMINIUM HSS-E

Macho de máquina especial aluminio HSS-E

44.0066

DIN
376

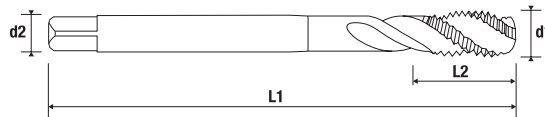

Cod.	M	d1	P	d2	L1	L2	Previous Hole Ø
440066M12	M12	12,00	1,75	9,00	110	19	10,20
440066M16	M16	16,00	2,00	12,00	110	20	14,00
440066M20	M20	20,00	2,50	16,00	140	25	17,50

M

HSS-E

6H
TOLERANCE

FORM
C
Px2,5

BRIGHT

ALU
NE

PLASTIC

GFK
CFK



HA



C. CONDITIONS



46.4070 46.4076

M

HSS-E-PM

6HX
TOLERANCE

FORM
C Px2,5

SHARK

TITAN
INCONEL

NI
ALLOYS

GG(G)



HA

HPC



MQL

HIGH PERFORMANCE MACHINE TAP HSS-E-PM

Macho de máquina de alto rendimiento HSS-E-PM

DIN
376

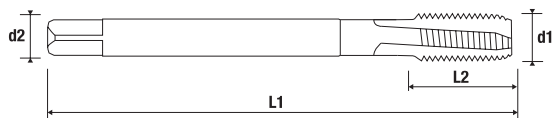

DIN
371

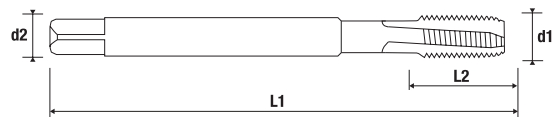

Cod.	M	d1	P	d2	L1	L2	Previous Hole Ø
464070M03	M3	3,00	0,50	3,50	56	10	2,50
464070M04	M4	4,00	0,70	4,50	63	12	3,30
464070M05	M5	5,00	0,80	6,00	70	14	4,20
464070M06	M6	6,00	1,00	6,00	80	16	5,00
464070M08	M8	8,00	1,25	8,00	90	17	6,80
464070M10	M10	10,00	1,50	10,00	100	20	8,50

Cod.	M	d1	P	d2	L1	L2	Previous Hole Ø
464076M12	M12	12,00	1,75	9,00	110	24	10,20
464076M16	M16	16,00	2,00	12,00	110	26	14,00



C. CONDITIONS
46.4070



C. CONDITIONS
46.4076