

# COVENTRY

TOOL BITS · COBALT HIGH SPEED STEEL

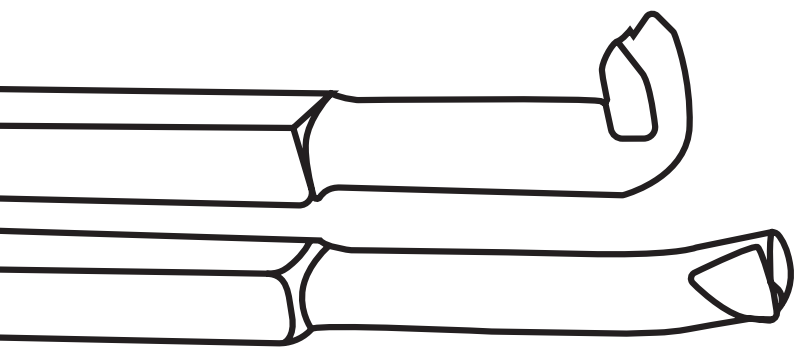





**COVENTRY**

TOOL BITS · COBALT HIGH SPEED STEEL

HELION TOOLS S.L.

C/ Miquel Servet 37  
Nau 13 P.l. Bufalvent  
CP 08243 · Manresa  
Barcelona · Spain

+34 93 877 08 69  
info@helion.tools  
www.helion.tools

IMPRESO ENgroc.ag



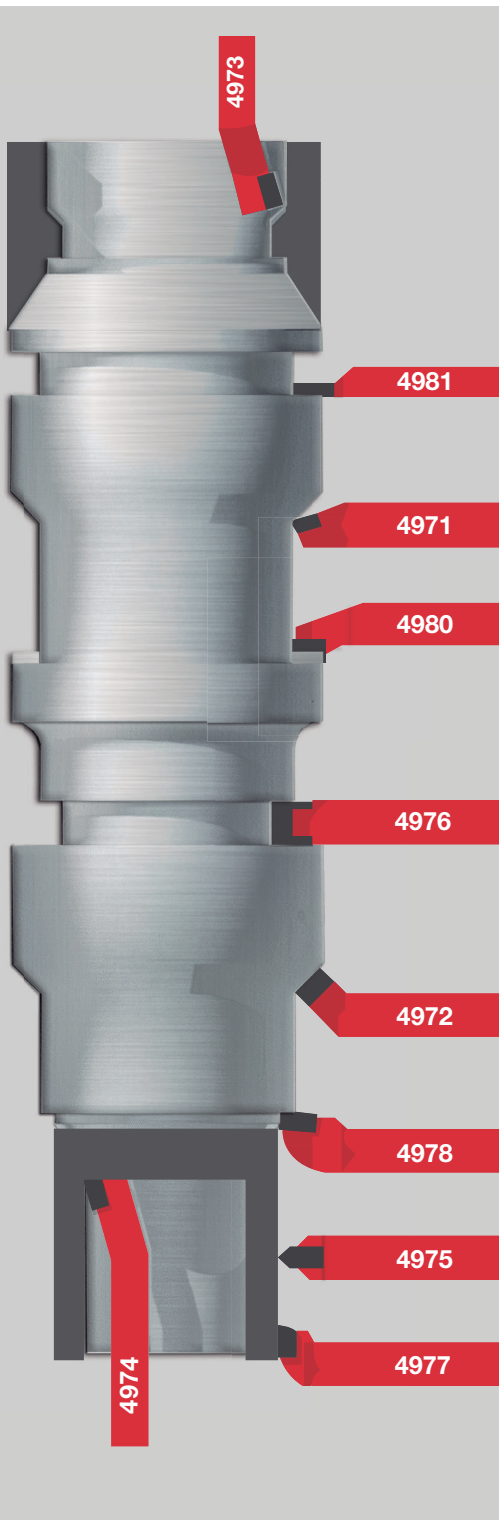

## PROGRAMA DE FABRICACIÓN

### HERRAMIENTAS PARA TORNO SOLDADAS DE METAL DURO

NORMA	DESCRIPCIÓN
DIN 4971 - ISO 1	Herramienta de torneado
DIN 4972 - ISO 2	Herramienta de torneado 45°
DIN 4978 - ISO 3	Herramienta de acabado
DIN 4976 - ISO 4	Herramienta para ataque frontal
DIN 4977 - ISO 5	Herramienta desplazada para frontales
DIN 4980 - ISO 6	Herramienta para torneado y refrentado
DIN 4981 - ISO 7	Herramienta de ranurar y tronzar
DIN 4973 - ISO 8	Herramienta de torneado interior
DIN 4974 - ISO 9	Herramienta de torneado interior
DIN 4975 - ISO 10	Herramienta de torno para acabados



DIN 282 - ISO 352	Herramienta para roscado exterior
DIN 283 - ISO 353	Herramienta para roscado interior
DIN 263 - ISO 354	Herramienta para ranurar interior



Pag. 4

### FORM A DIN 4964

CUCHILLA REDONDA  
TOOL BITS



Pag. 5

### FORM B DIN 4964

CUCHILLA CUADRADA  
TOOL BITS

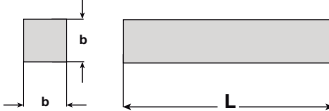

Pag. 6

### FORM D DIN 4964

CUCHILLA RECTANGULAR  
TOOL BITS

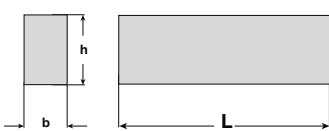

Pag. 9

### FORM E DIN 4964

CUCHILLA TRAPEZOIDAL  
TOOL BITS

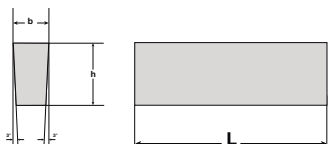

Pag. 12

### FORM L-1 DIN 4964

CUCHILLA TRAPEZOIDAL  
PARTING OFF TOOL BITS

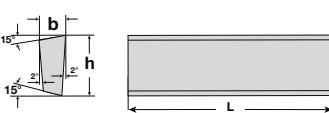

Pag. 12

### FORM L-2 DIN 4964

CUCHILLA BITRAPEZOIDAL  
PARTING OFF TOOL BITS

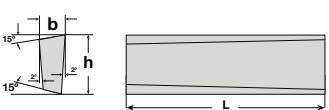

Pag. 13

### ISO - 1 DIN 4971

HERRAMIENTA DE TORNEAR

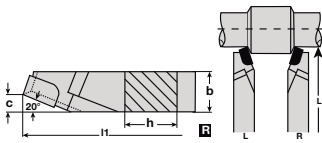

Pag. 13

### ISO - 2 DIN 4972

HERRAMIENTA DE  
TORNEAR 45°

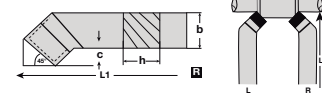

Pag. 13

### ISO - 3 DIN 4978

HERRAMIENTA DE ACABADO

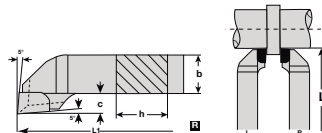

Pag. 14

### ISO - 4 DIN 4976

HERRAMIENTA PARA  
ATAQUE FRONTAL

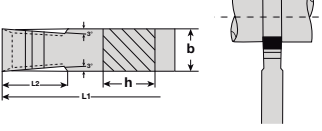

Pag. 14

### ISO - 5 DIN 4977

HERRAMIENTA  
DESPLAZADA PARA  
FRONTALES

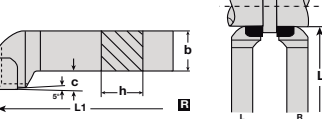

Pag. 14

### ISO 6 DIN 4980

HERRAMIENTA PARA  
TORNEAR Y  
REFRENTAR

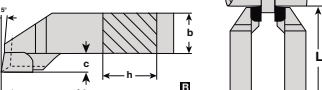

Pag. 15

### ISO - 7 DIN 4981

HERRAMIENTA DE  
RANURAR Y  
TRONZAR

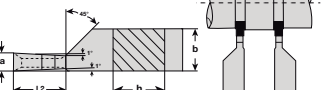

Pag. 15

### ISO - 8 DIN 4973

HERRAMIENTA DE  
TORNEADO INTERIOR

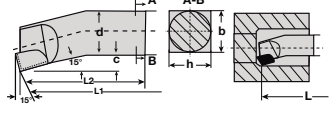

Pag. 15

### ISO - 9 DIN 4974

HERRAMIENTA DE  
TORNEADO INTERIOR

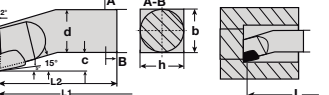

Pag. 16

### ISO - 10 DIN 4975

HERRAMIENTA DE TORNO  
PARA ACABADOS

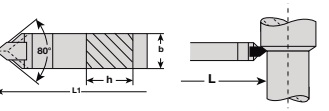

Pag. 17

### ISO 352 DIN 282

HERRAMIENTA PARA  
ROSCADO  
EXTERIOR

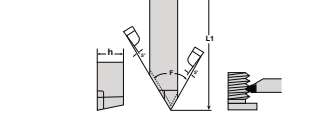

Pag. 17

### ISO 353 DIN 283

HERRAMIENTA PARA  
ROSCADO  
INTERIOR

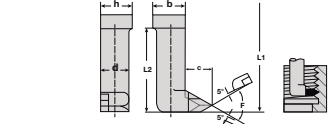

Pag. 17

### ISO 354 DIN 263

HERRAMIENTA  
PARA RANURADO  
INTERIOR

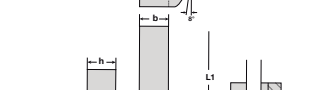



	COVENTRY			COVENTRY PLACA SOLDADA			
	CO 10%	SPEZIAL	ASP-60	P-20	P-40	K-10	M-10
MATERIAL DE FABRICACIÓN MATERIAL MANUFACTURING	Acero rápido HSS-E aleación Cobalto 10% Calidad universal de primera opción. Average speed steel 10% cobalt alloy. First choice quality.	Acero rápido de aleación alta en Cobalto, Tungsteno y Carbono. High-speed steel cobalt alloy, Tungsten and Carbon.	Acero sinterizado pulvimetalúrgico ASP-60 aleación grano fino Cobalto, Tungsteno y Carbono. High alloy ASP-60 powder metallurgical grade with a more even distribution of Cobalt, Tungsten and Carbide particles.	Metal duro de primera calidad importado de Alemania y bajo las normas ISO. Premium carbide imported from Germany and under ISO.			
APLICACIONES APPLICATIONS	Torneado, tronzado y herramientas de corte diversas planas y rotativas. Turning, grooving and parting off. General purpose cutting tools	Torneado de alto avance. Profundidades de corte medios. High feed turning. Means cutting depths.	Elevada resistencia al desgaste en torneado y tronzado. High wear resistance. High strength cutting edge.	Torneado, ranurado, roscado. Mecanizado en general. Turning, grooving, threading. General machining.	Torneado, ranurado, corte interrumpido o grandes avances. Turnind, grooving, high feed or difficult conditions.	Torneado, ranurado, roscado. Mecanizado en general. Turning, grooving, threading. General machining.	Torneado, ranurado, roscado. Mecanizado en general. Turning, grooving, threading. General machining.
MECANIZACIÓN MACHINNING	Materiales tenaces Madera Extrusión Herramientas de cizallar Tough materials Wood Extrusion Shearing tools	Materiales tenaces Madera Extrusión Herramientas de cizallar Tough materials Wood Extrusion Shearing tools	Aceros al carbono, aceros aleados, aleaciones de aluminio, aceros refractarios. Carbon steel, stainless steel, aluminium alloys, heat resistant alloys.	Calidad universal para mecanizado de aceros en general. Firts choice grade for general turning steel.	Mecanizado de acero en condiciones difíciles, bajas velocidades o corte interrumpido. Steel machininig under difficult conditions.	Mecanizado universal de fundiciones, aluminios y materiales abrasivos. Aleaciones de cobre a alta temperatura. Universal grade for cast iron, aluminium, abrasive materials and cooper alloys.	Mecanizado de aceros inoxidables y aceros al manganeso. Turning stainless steels and wear resistance manganese steels.
RESISTENCIA RESISTANCE	Alta tenacidad y resistencia al choque. Allowed in difficult cutting conditions.	Alta resistencia al desgaste y a las mecanizaciones con alta concentración de calor. High wear resistance and machining with high concentration of heat.	Alta resistencia al desgaste. Alta resistencia de la arista de corte. High wear resistance. High strenght cutting edge.	Alta resistencia al desgaste. High wear resistance.	Alta tenacidad y resistencia al choque. Allowed in difficult cutting conditions.	Alta resistencia al desgaste. High wear resistance.	Alta resistencia al desgaste. High wear resistance.
AFILIADOS REGRINDING	Afilado sin problemas con muelas cerámicas o CBN Regrinding easily with ceramic or CBN wheels.	Afilado sin problemas con muelas cerámicas o CBN Regrinding easily with ceramic or CBN wheels.	Afilado sin problemas con muelas cerámicas o CBN Regrinding easily with ceramic or CBN wheels.	Muelas de carburo de sicilio y acabado con muela de diamante. Silicon carbide wheel, finish with diamond wheel.			
CARACTERÍSTICAS ESPECIALES SPECIAL FEATURES	Excelentes resultados en amplia gama de materiales. Good results in wide materials range.	Resistencia al desgaste en el filo de corte mejorada. Better wear resistance at cutting edge.	Mayor productividad por más altas condiciones de corte y mayor resistencia al desgaste. Increased producti-vity by higher cutting conditions and increase wear resistance.	Rendimiento óptimo en procesos de mecanizado. Optimal performance in machining processes.			



## FORM A DIN 4964

CUCHILLA REDONDA / TOOL BITS

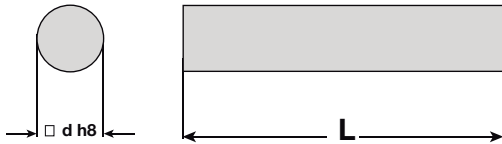

d mm.	l mm.	Precio / Euros / Pieza		
		Co 10%	Spezial	ASP-60
2	100	12,08	17,08	*
2,5	100	12,08	*	*
3	100	5,18	7,32	*
3	160	10,35	14,64	*
3	200	13,80	*	*
4	100	5,18	7,32	*
4	160	8,97	12,69	*
4	200	11,21	15,86	*
5	100	5,69	8,05	*
5	160	10,35	14,64	*
5	200	13,11	18,54	*
6	100	6,56	9,27	*
6	160	9,83	13,91	*
6	200	12,59	17,81	*
7	100	11,39	16,10	*
7	160	15,53	21,96	*
7	200	18,98	26,84	*
8	100	8,45	11,96	*
8	160	13,63	19,28	*
8	200	16,56	23,42	*
9	100	12,94	18,30	*

d mm.	l mm.	Precio / Euros / Pieza		
		Co 10%	Spezial	ASP-60
9	200	25,88	36,60	*
10	100	10,97	15,52	*
10	160	16,04	22,69	*
10	200	20,36	28,79	*
11	200	60,38	*	*
12	100	12,87	18,20	*
12	160	22,25	31,48	*
12	200	26,74	37,82	*
13	150	37,10	*	*
13	200	62,10	*	*
14	100	18,80	26,60	*
14	160	29,33	41,48	*
14	200	37,95	53,68	*
16	100	23,98	33,92	*
16	160	37,09	52,46	*
16	200	45,20	63,93	*
18	160	41,23	58,32	*
18	200	51,75	73,20	*
20	200	63,83	90,28	*
22	200	143,18	202,52	*
25	200	103,50	146,40	*





**FORM B DIN 4964**

**CUCHILLA CUADRADA / TOOL BITS**

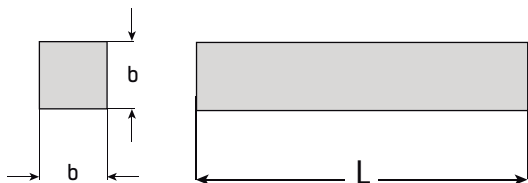

b mm.	b mm.	l mm.	Precio / Euros / Pieza		
			Co 10%	Spezial	ASP-60
4	4	100	7,76	11,62	*
4	4	160	11,73	17,57	*
4	4	200	14,66	21,96	*
5	5	100	7,07	10,59	*
5	5	160	11,73	17,57	*
5	5	200	14,66	21,96	*
6	6	100	5,97	8,94	*
6	6	160	9,66	14,47	*
6	6	200	12,08	18,09	*
7	7	200	18,10	27,11	*
8	8	100	10,11	15,14	*
8	8	160	13,80	20,67	*
8	8	200	16,04	24,03	*
8	8	300	35,00	*	*
10	10	100	13,80	20,67	*
10	10	160	19,67	29,46	*
10	10	200	24,15	36,18	*

b mm.	b mm.	l mm.	Precio / Euros / Pieza		
			Co 10%	Spezial	ASP-60
10	10	300	*	*	*
12	12	100	17,25	25,84	*
12	12	160	26,57	39,79	*
12	12	200	31,91	47,80	*
12	12	300	51,75	*	*
14	14	100	21,56	32,30	*
14	14	125	26,74	*	*
14	14	160	32,78	49,10	*
14	14	200	38,12	57,11	*
16	16	100	25,88	38,76	*
16	16	125	31,23	*	*
16	16	160	38,30	57,37	*
16	16	200	45,37	67,96	*
18	18	200	71,76	107,50	*
20	20	200	72,45	108,53	*
25	25	200	115,58	173,13	*

## FORM D DIN 4964

CUCHILLA RECTANGULAR  
TOOL BITS

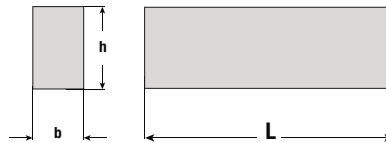

h mm.	b mm.	l mm.	Precio / Euros / Pieza		
			Co 10%	Spezial	ASP-60
6	4	80	7,76	11,63	*
6	4	100	8,45	12,66	*
6	4	125	11,73	17,57	*
6	4	150	15,18	22,74	*
6	4	160	15,18	22,74	*
6	4	200	18,98	28,42	*
8	8	63	7,25	10,85	*
8	2	80	8,97	13,44	*
8	2	100	10,70	16,02	*
8	2	125	12,94	19,38	*
8	2	150	16,56	24,81	*
8	2	160	16,56	24,81	*
8	2	200	21,39	32,04	*
8	4	80	7,76	11,63	*
8	4	100	8,45	12,66	*
8	4	125	11,73	17,57	*
8	4	160	15,18	22,74	*
8	4	200	18,98	28,42	*
8	6	80	9,66	14,47	*
8	6	100	11,21	16,80	*
8	6	125	14,15	21,19	*
8	6	150	18,11	27,13	*
8	6	160	18,11	27,13	*
8	6	200	22,43	33,59	*
10	3	80	9,66	14,47	*
10	3	100	11,21	16,80	*
10	3	125	14,15	21,19	*
10	3	150	18,11	27,13	*
10	3	160	18,11	27,13	*

h mm.	b mm.	l mm.	Precio / Euros / Pieza		
			Co 10%	Spezial	ASP-60
10	3	200	22,43	33,59	*
10	4	100	8,45	12,66	*
10	4	125	11,73	17,57	*
10	4	150	15,18	22,74	*
10	4	160	15,18	22,74	*
10	4	200	18,98	28,42	*
10	5	100	10,01	14,99	*
10	5	150	16,22	24,29	*
10	5	200	20,01	29,97	*
10	6	100	10,70	16,02	*
10	6	125	12,94	19,38	*
10	6	150	16,56	24,81	*
10	6	160	16,56	24,81	*
10	6	200	20,70	31,01	*
10	8	100	11,21	16,80	*
10	8	125	14,15	21,19	*
10	8	160	18,11	27,13	*
10	8	200	22,43	33,59	*
12	3	100	11,56	17,31	*
12	3	125	14,49	21,71	*
12	3	160	18,29	27,39	*
12	3	200	23,46	35,14	*
12	4	100	11,90	17,83	*
12	4	150	19,84	29,72	*
12	4	160	19,84	29,72	*
12	4	200	25,01	37,47	*



**FORM D DIN 4964**

**CUCHILLA RECTANGULAR  
TOOL BITS**

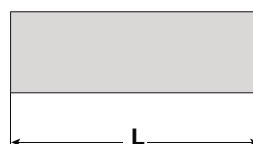
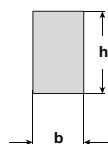

h mm.	b mm.	l mm.	Precio / Euros / Pieza		
			Co 10%	Spezial	ASP-60
12	6	100	11,21	16,80	*
12	6	125	14,15	21,19	*
12	6	150	16,39	24,55	*
12	6	160	16,39	24,55	*
12	6	200	20,36	30,49	*
12	8	100	12,08	18,09	*
12	8	125	15,70	23,51	*
12	8	150	18,98	28,42	*
12	8	160	18,98	28,42	*
12	8	200	23,63	35,40	*
12	10	100	15,87	23,77	*
12	10	125	19,67	29,46	*
12	10	150	25,01	37,47	*
12	10	160	25,01	37,47	*
12	10	200	31,05	46,51	*
14	6	100	16,39	24,55	*
14	6	125	20,18	30,23	*
14	6	150	25,88	38,76	*
14	6	160	25,88	38,76	*
14	6	200	32,78	49,10	*
14	8	200	37,95	56,85	*
14	10	100	24,15	36,18	*
14	10	160	38,99	58,40	*
14	10	200	48,30	72,35	*
14	12	100	30,19	45,22	*
14	12	160	48,30	72,35	*
14	12	200	60,38	90,44	*
15	3	100	21,05	31,53	*

h mm.	b mm.	l mm.	Precio / Euros / Pieza		
			Co 10%	Spezial	ASP-60
15	3	150	33,81	50,65	*
15	3	200	42,09	63,05	*
15	4	100	15,70	23,51	*
15	4	150	25,01	37,47	*
15	4	200	31,05	46,51	*
15	5	100	17,08	25,58	*
15	5	150	27,08	40,57	*
15	5	200	33,64	50,39	*
16	6	100	16,39	24,55	*
16	6	150	25,88	38,76	*
16	6	200	32,78	49,10	*
16	8	100	20,70	31,01	*
16	8	150	25,88	38,76	*
16	8	200	32,78	49,10	*
16	10	100	18,98	28,42	*
16	10	125	24,15	36,18	*
16	10	150	31,05	46,51	*
16	10	160	31,05	46,51	*
16	10	200	37,95	56,85	*
16	12	100	30,19	45,22	*
16	12	125	39,68	59,43	*
16	12	150	48,30	72,35	*
16	12	160	48,30	72,35	*
16	12	200	56,93	85,27	*
18	4	100	13,46	20,16	*
18	4	150	21,39	32,04	*
18	4	160	21,39	32,04	*

## FORM D DIN 4964

CUCHILLA RECTANGULAR  
TOOL BITS

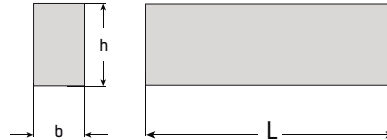

h mm.	b mm.	l mm.	Precio / Euros / Pieza		
			Co 10%	Spezial	ASP-60
18	4	200	26,74	40,05	*
18	6	100	18,63	27,91	*
18	6	150	29,33	43,93	*
18	6	160	29,33	43,93	*
18	6	200	36,23	54,27	*
20	3	100	14,66	21,96	*
20	3	150	24,15	36,18	*
20	3	200	28,46	42,64	*
20	4	100	14,15	21,19	*
20	4	150	22,94	34,37	*
20	4	200	28,12	42,12	*
20	5	150	25,01	37,47	*
20	5	200	31,05	46,51	*
20	6	150	27,26	40,83	*
20	6	200	33,64	50,39	*
20	8	150	41,40	62,02	*
20	8	200	48,30	72,35	*
20	10	150	42,78	64,08	*
20	10	200	53,48	80,11	*
20	10	250	74,18	111,11	*
20	12	150	49,68	74,42	*
20	12	200	62,10	93,03	*
20	12	250	85,39	127,91	*
20	16	150	67,79	101,55	*
20	16	200	69,00	103,36	*
25	6	100	21,74	32,56	*
25	6	150	34,67	51,94	*
25	6	200	43,13	64,60	*

h mm.	b mm.	l mm.	Precio / Euros / Pieza		
			Co 10%	Spezial	ASP-60
25	8	150	39,68	59,43	*
25	8	200	49,34	73,90	*
25	10	150	47,44	71,06	*
25	10	200	58,65	87,86	*
25	10	250	81,08	121,45	*
25	12	150	44,85	67,19	*
25	12	200	62,10	93,03	*
25	12	250	85,39	127,91	*
25	14	200	84,53	126,62	*
25	15	200	91,43	136,95	*
25	16	150	72,45	108,53	*
25	16	200	89,70	134,37	*
25	16	250	123,34	184,76	*
25	16	300	148,35	222,23	*
25	20	150	136,28	204,14	*
25	20	200	169,05	253,24	*
25	20	250	232,88	348,85	*
25	20	300	279,45	418,62	*
30	6	150	42,26	63,31	*
30	6	200	51,75	77,52	*
30	8	150	67,28	100,78	*
30	8	200	83,66	125,33	*
30	12	150	130,41	195,35	*
30	12	200	162,15	242,90	*
30	15	200	143,18	214,48	*
30	20	200	210,45	315,25	*



**FORM E DIN 4964**

CUCHILLA TRAPEZOIDAL  
TOOL BITS

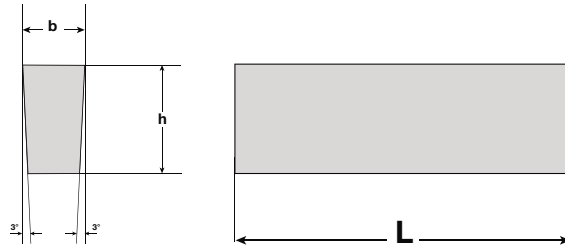

h mm.	b mm.	l mm.	Precio / Euros / Pieza		
			Co 10%	Spezial	ASP-60
10	2	63	12,08	*	*
10	2	80	15,53	*	*
10	2	100	21,56	*	*
10	2	125	25,88	*	*
10	2	150	27,95	*	*
10	2	160	33,64	*	*
10	3	100	18,98	*	*
10	3	200	37,95	*	*
10	2,5	50	12,08	*	*
10	2,5	63	12,08	*	*
10	2,5	80	12,94	*	*
10	2,5	100	15,53	*	*
10	2,5	125	20,70	*	*
10	2,5	150	25,88	*	*
10	2,5	160	25,88	*	*
10	2,5	200	31,05	*	*
12	3	63	7,07	*	*
12	3	75	7,07	*	*
12	3	80	7,07	*	*
12	3	100	8,97	*	*
12	3	125	11,21	*	*
12	3	150	13,80	*	*
12	3	160	13,80	*	*
12	3	200	17,25	*	*
12	4	80	21,39	*	*
12	4	125	32,26	*	*
12	4	160	41,40	*	*
12	4	200	51,75	*	*
12	5	80	13,80	*	*

h mm.	b mm.	l mm.	Precio / Euros / Pieza		
			Co 10%	Spezial	ASP-60
12	5	100	15,53	*	*
12	5	125	17,42	*	*
12	5	160	22,08	*	*
12	5	200	29,33	*	*
12	1,5	200	25,88	*	*
12	1,6	100	12,08	*	*
13	2,5	100	17,25	*	*
13	2,5	160	27,60	*	*
15	3	80	24,15	*	*
15	3	100	25,88	*	*
15	3	125	32,78	*	*
15	3	150	43,13	*	*
15	3	160	43,13	*	*
15	3	200	51,75	*	*
15	4	80	20,70	*	*
15	4	100	25,88	*	*
15	4	125	30,71	*	*
15	4	160	39,68	*	*
15	4	200	49,85	*	*
15	2,5	100	25,88	*	*



**FORM E DIN 4964**

**CUCHILLA TRAPEZOIDAL  
TOOL BITS**

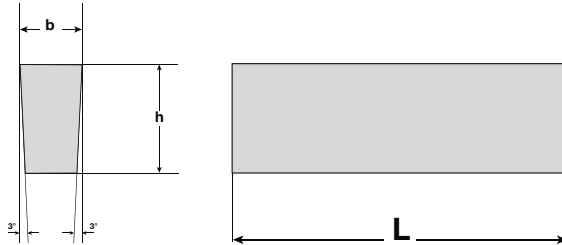

h mm.	b mm.	l mm.	Precio / Euros / Pieza		
			Co 10%	Spezial	ASP-60
15	2,5	140	39,68	*	*
15	2,5	160	37,95	*	*
16	3	80	22,43	*	*
16	3	100	25,53	*	*
16	3	125	26,22	*	*
16	3	150	43,13	*	*
16	3	160	43,13	*	*
16	3	200	51,75	*	*
16	4	80	12,94	*	*
16	4	100	15,53	*	*
16	4	125	20,70	*	*
16	4	140	25,88	*	*
16	4	150	25,88	*	*
16	4	160	25,88	*	*
16	4	200	31,05	*	*
16	4	250	43,13	*	*
16	6	100	27,60	*	*
16	6	125	35,71	*	*
16	6	140	44,85	*	*
18	3	80	12,94	*	*
18	3	100	15,53	*	*
18	3	125	20,70	*	*
18	3	150	25,88	*	*
18	3	160	25,88	*	*
18	3	200	31,05	*	*
18	4	80	12,94	*	*
18	4	100	15,53	*	*
18	4	125	20,70	*	*
18	4	150	25,88	*	*

h mm.	b mm.	l mm.	Precio / Euros / Pieza		
			Co 10%	Spezial	ASP-60
18	4	160	25,88	*	*
18	4	200	31,05	*	*
18	5	125	41,40	*	*
18	5	160	51,75	*	*
18	5	200	65,55	*	*
18	6	80	17,25	*	*
18	6	100	20,70	*	*
18	6	125	25,88	*	*
18	6	160	33,64	*	*
18	6	200	41,40	*	*
18	6	250	51,75	*	*
19	3,5	125	31,05	*	*
19	3,5	160	37,95	*	*
20	3	100	18,98	*	*
20	3	125	23,29	*	*
20	3	150	29,33	*	*
20	3	160	29,33	*	*
20	3	200	36,23	*	*
20	3	250	39,68	*	*



**FORM E DIN 4964**

**CUCHILLA TRAPEZOIDAL  
TOOL BITS**

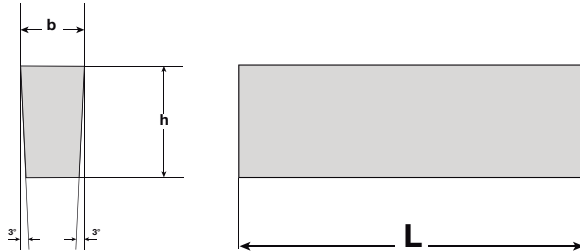

h mm.	b mm.	l mm.	Precio / Euros / Pieza		
			Co 10%	Spezial	ASP-60
20	4	100	19,49	*	*
20	4	125	24,15	*	*
20	4	150	30,36	*	*
20	4	160	30,36	*	*
20	4	200	37,95	*	*
20	4	250	43,13	*	*
20	5	50	18,11	*	*
20	5	63	18,11	*	*
20	5	80	18,11	*	*
20	5	100	22,43	*	*
20	5	125	28,46	*	*
20	5	150	36,23	*	*
20	5	160	36,23	*	*
20	5	200	44,85	*	*
20	5	250	56,93	*	*
20	6	150	51,75	*	*
20	6	160	51,75	*	*
20	6	200	63,83	*	*
20	6	250	86,25	*	*
25	4	100	39,68	*	*
25	4	200	72,45	*	*
25	5	100	39,68	*	*
25	5	125	50,03	*	*
25	5	160	63,48	*	*
25	5	200	77,63	*	*
25	5	250	100,91	*	*
25	6	50	31,05	*	*
25	6	80	31,05	*	*

h mm.	b mm.	l mm.	Precio / Euros / Pieza		
			Co 10%	Spezial	ASP-60
25	6	100	37,95	*	*
25	6	125	47,44	*	*
25	6	160	61,24	*	*
25	6	200	75,90	*	*
25	6	250	98,33	*	*
32	8	80	51,75	*	*
32	8	100	64,69	*	*
32	8	125	80,56	*	*
32	8	150	103,50	*	*
32	8	160	103,50	*	*
32	8	200	129,38	*	*
32	8	250	165,60	*	*
32	8	300	201,83	*	*
40	10	100	117,30	*	*
40	10	125	146,63	*	*
40	10	150	187,68	*	*
40	10	200	234,77	*	*
40	10	250	307,05	*	*
40	10	300	376,05	*	*



**FORM L-1** **DIN 4964** **CUCHILLA TRAPEZOIDAL PARTING OFF TOOL BITS**

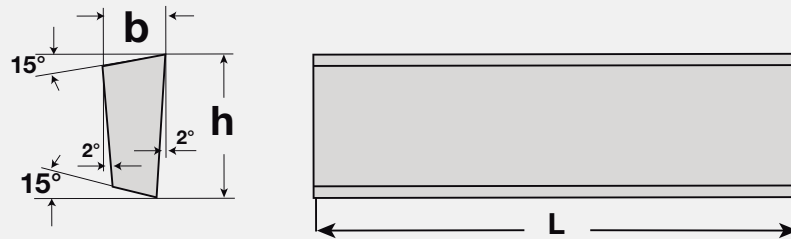

b mm.	h mm.	l mm.	Precio / Euros / Pieza		
			Co 10%	Spezial	ASP-60
2,5	13	100	12,54	*	*
2,5	15	100	12,94	*	*
3,5	19	125	21,09	*	35,85

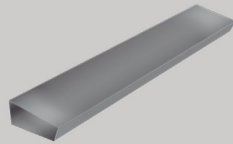

**FORM L-2** **DIN 4964** **CUCHILLA BITRAPEZOIDAL PARTING OFF TOOL BITS**

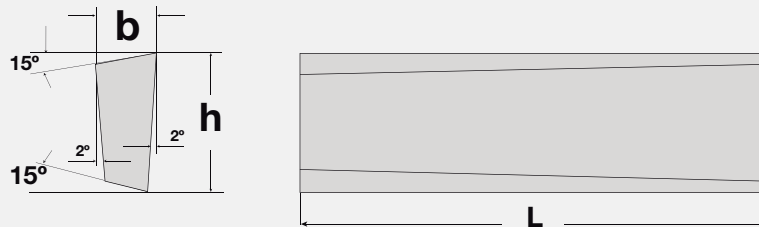

b mm.	h mm.	l mm.	Precio / Euros / Pieza		
			Co 10%	Spezial	ASP-60
2,5	13	100	13,42	20,16	*
2,5	15	100	13,42	20,13	*
3,5	19	125	22,16	30,50	37,67

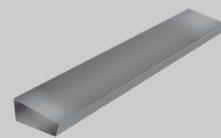





**ISO 1 DIN 4971 R/L**

**HERRAMIENTA DE TORNEAR**

h mm.	b mm.	l mm.	Precio en euros por pieza / Price € part		
			P-20	K-10	P-40 M-20
10	10	90	6,93		*
12	12	100	8,10		*
16	16	110	9,36		10,40
20	20	125	12,06		13,32
25	25	140	19,49		21,56
32	32	170	29,25		*
40	40		52,70		*

**ISO 2 DIN 4972 R/L**

**HERRAMIENTA DE TORNEAR 45°**

h mm.	b mm.	l mm.	Precio en euros por pieza / Price € part		
			P-20	K-10	P-40 M-20
10	10	90	7,29		*
12	12	100	8,46		9,36
16	16	110	9,77		10,76
20	20	125	12,42		13,73
25	25	140	19,62		21,69
32	32	170	29,39		32,27
40	40		53,24		58,59

**ISO 3 DIN 4978 R/L**

**HERRAMIENTA DE ACABADO**

h mm.	b mm.	l mm.	Precio en euros por pieza / Price € part			
			P-20	K-10	P-40	M-20
8	8	80	9,00			9,86
10	10	90	8,73			9,63
12	12	100	10,26			11,30
16	16	110	11,40			12,56
20	20	125	16,90			18,72
25	25	140	27,25			30,78
32	32	170	39,11			43,11



## ISO 4 DIN 4976 R/L

### HERRAMIENTA PARA ATAQUE FRONTAL

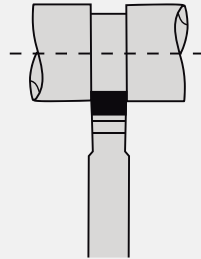
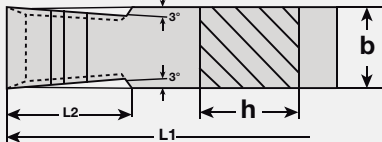

h mm.	b mm.	l mm.	Precio en euros por pieza / Price € part			
			P-20	K-10	P-40	M-20
8	8	80	9,09		*	
10	10	90	7,68		8,46	
12	12	100	9,98		11,00	
16	16	110	11,90		13,19	
20	20	125	16,13		17,80	
25	25	140	28,10		30,92	
32	32	170	48,15		53,10	
40	40	200	90,41		99,54	

## ISO 5 DIN 4977 R/L

### HERRAMIENTA DESPLAZADA PARA FRONTALES

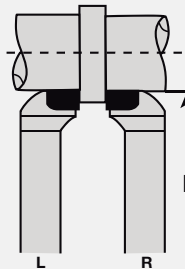
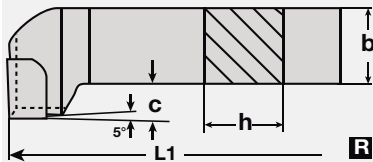

h mm.	b mm.	l mm.	Precio en euros por pieza / Price € part			
			P-20	K-10	P-40	M-20
8	8	80	8,33		*	
10	10	90	7,97		8,87	
12	12	100	9,09		10,13	
16	16	110	9,98		11,03	
20	20	125	12,83		14,13	
25	25	140	19,72		21,83	
32	32	170	30,15		33,21	

## ISO 6 DIN 4980 R/L

### HERRAMIENTA PARA TORNEAR Y REFRENTAR

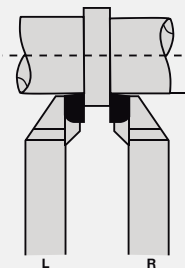
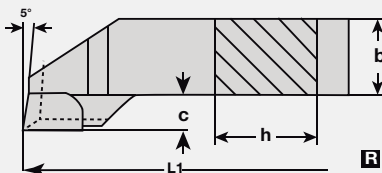

h mm.	b mm.	l mm.	Precio en euros por pieza / Price € part			
			P-20	K-10	P-40	M-20
8	8	80	9,00		*	
10	10	90	7,07		7,83	
12	12	100	8,10		9,00	
16	16	110	9,86		10,89	
20	20	125	12,33		13,59	
25	25	140	18,72		20,66	
32	32	170	28,49		31,41	
40	40	200	53,24		58,59	



**ISO 7 DIN 4981 R/L**

**HERRAMIENTA DE RANURAR Y TRONZAR**

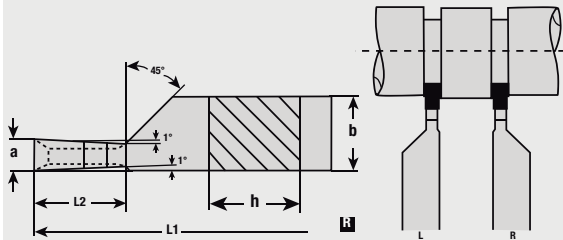

h mm.	b mm.	l mm.	L2 mm.	a mm.	Precio en euros por pieza / Price € part			
					P-20	K-10	P-40	M-20
12	8		12	3	7,29		8,10	
16	10		14	4	7,97		8,87	
20	12		16	5	9,63		10,67	
25	16		20	6	13,73		15,12	
32	20		25	8	19,13		21,02	
40	25		32	10	32,45		*	

**ISO 8 DIN 4973 R**

**HERRAMIENTA DE TORNEADO INTERIOR**

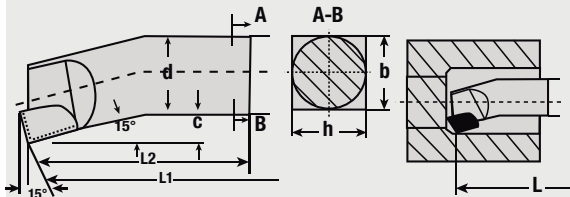

h mm.	b mm.	l mm.	L2 mm.	Ø mm.	Precio en euros por pieza / Price € part			
					P-20	K-10	P-40	M-20
8	8	125	40	14	7,20		7,97	
10	10	150	50	18	7,97		8,87	
12	12	180	63	21	9,86		10,89	
16	16	210	80	27	12,06		13,32	
20	20	250	100	34	14,63		16,16	
25	25	300	125	43	22,59		24,89	
32	32	355	160	52	33,84		37,25	
40	40	400	180	60	56,43		84,50	

**ISO 9 DIN 4974**

**HERRAMIENTA DE TORNEADO INTERIOR**

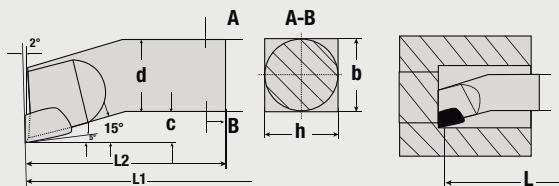

h mm.	b mm.	l mm.	L2 mm.	Ø mm.	Precio en euros por pieza / Price € part			
					P-20	K-10	P-40	M-20
8	8	125	40	14	7,20		7,97	
10	10	150	50	18	7,97		8,87	
12	12	180	63	21	9,86		10,89	
16	16	210	80	27	12,06		13,32	
20	20	250	100	34	14,63		16,16	
25	25	300	125	43	22,59		24,89	
32	32	355	160	52	33,84		37,25	
40	40	400	180	60	76,43		84,50	



## ISO 10 DIN 4975

### HERRAMIENTA DE TORNO PARA ACABADOS

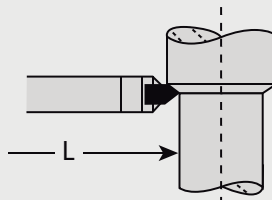
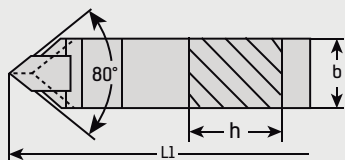

h mm.	b mm.	l mm.	Precio en euros por pieza / Price € part			
			P-20	K-10	P-40	M-20
10	10	90	7,56		*	
12	12	100	9,36		*	
16	16	110	11,43			12,56
20	20	125	15,39			16,92
25	25	140	25,92			28,65
32	32	170	*			57,74



**ALTA TENACIDAD**

COVENTRY SPEZIAL



**ISO 352 DIN 282 60° R**

**HERRAMIENTA PARA ROSCADO EXTERIOR**

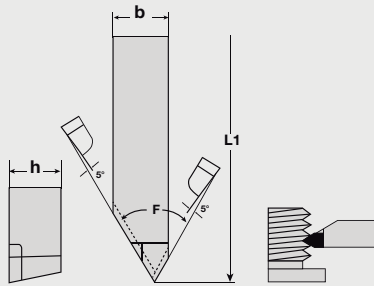

h mm.	b mm.	l mm.	Precio en euros por pieza / Price € part			
			P-20	K-10	P-40	M-20
12	8	100	15,39			*
16	10	120	18,72			*
20	12	140	21,29			*
25	16	160	25,52			*
32	20	180	*			*
40	25	200	*			*

**ISO 353 DIN 283 60° R**

**HERRAMIENTA PARA ROSCADO INTERIOR**

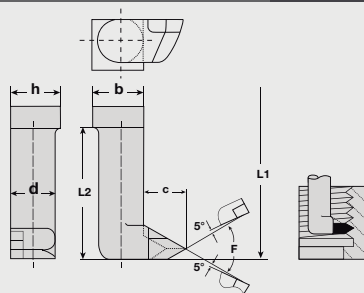

h mm.	b mm.	l mm.	L2 mm.	Ø min	Precio en euros por pieza / Price € part			
					P-20	K-10	P-40	M-20
10	10	140	30	22	19,11			*
12	12	160	35	26	20,90			*
16	16	140	45	32	24,62			*
20	20	160	55	38	27,45			*
25	25	200	65	45	34,88			*
32	32	250	75	58	*			*

**ISO 354 DIN 263 R**

**HERRAMIENTA PARA RANURADO INTERIOR**

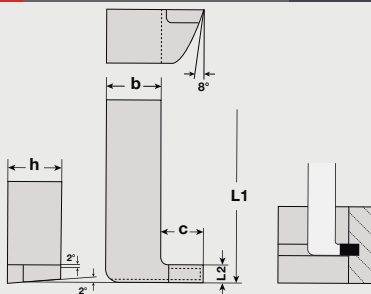

h mm.	b mm.	l mm.	L2 mm.	Ø min	Precio en euros por pieza / Price € part			
					P-20	K-10	P-40	M-20
10	10	140	3	22	18,95			*
12	12	160	4	25	20,90			*
16	16	180	5	34	24,62			*
20	20	210	6	42	27,45			*
25	25	250	8	60	34,88			*
32	32	300	10	65	48,74			*
40	40	315	12	75	*			*



## CONDICIONES DE VENTA

- **Pago:**

El pago se efectuará de conformidad con los términos y condiciones notificadas al comprador. Por impago de los bienes entregados, Helion puede cobrar el interés legal de demora en las cuentas vencidas y tendrá derecho a tomar las medidas necesarias a fin de garantizar el cobro de estos pagos.

- **Reserva de dominio:**

La propiedad de los bienes no se transmitirá al comprador hasta que se haga efectivo por completo su pago. La Empresa se reserva el derecho de tomar posesión de los bienes respecto de los cuales mora en el pago

- **Transporte y seguro:**

Será pagada por el comprador.

La mercancía siempre viaja por cuenta y riesgo del comprador y será a su cargo la prima del seguro en caso de que el cliente lo solicite.

- **Reclamaciones:**

Las reclamaciones sólo serán tramitadas si se reciben dentro de los 30 días siguientes a la recepción de las mercancías.

- **Retorno de bienes:**

Productos devueltos sólo serán aceptados por Helion previo acuerdo expreso y por escrito. El valor de las mercancías de retorno será el valor de la compra. El albarán de entrega tiene que ser entregado con las mercancías de retorno, así como el documento de aceptación del departamento de control de calidad.

En caso de devolución de herramientas estándar, salvo en condiciones de garantía, se cobrará el 15% del precio en concepto de manipulación y control.

En ningún caso se aceptara la devolución de herramientas especiales producidos por petición del cliente.

- **Características técnicas:**

Las especificaciones técnicas se pueden encontrar en el catálogo. Helion reserva el derecho de cambiar algunas de estas especificaciones sin previo aviso.

- **Garantía:**

Garantizamos la calidad de nuestras herramientas en cuanto a fabricación y materiales se refiere, pero no en caso de manipulación inadecuada o modificación de la geometría original.

La garantía excluye totalmente la responsabilidad por daños y sus consecuencias.

- **Entrega:**

Cualquier fecha de entrega se calcula lo más corto posible, pero solo a título orientativo.

En caso de retraso Helion no acepta ninguna reclamación o anulaciones de herramientas especiales producidos por petición del cliente.

- **Jurisdicción:**

En caso de litigio, el cliente estará sujeto a la jurisdicción de los Tribunales de Manresa.



## SALES TERM

- **Payment:**

Payment shall be made in accordance with terms and conditions notified to the buyer. In default of payment of delivered goods Helion may charge the buyer interest on overdue accounts and shall be entitled to take the necessary steps in order to ensure the collection of these payments.

- **Passing of property:**

The property of the goods does not pass to the buyer until it becomes entirely his payment. The Company reserves the right to repossess any goods in respect on which payment is overdue and the buyer shall co-operate in the event of the Company notifying its intentions of repossess.

- **Transport and insurance:**

Will be payed by the buyer

The merchandise always travels at the risk of the buyer being responsible for the cost of insurance if requested.

- **Claims:**

Claims will only registered if received within 30 days of the receipt of goods .

- **Return of goods:**

Goods returned will only be accepted by the Company provided prior arrangements have been made. The value of the returned goods will be the purchase value. The delivery note has to be handed in with the returned goods, as well as the acceptance document of the quality control department.

In case of return of standard tools, Helion Tools reserve the right to charge 15% of the selling price in concept of handling and control.

In case of special tools, accepted in advance, Helion Tools will not accept the return.

- **Technical features:**

Technical specifications can be found in the catalog. Helion reserve the right to change some of these specifications without prior notice.

- **Warranty:**

We warranty the quality of our tools is so far as manufacture and materials are concerned, but not against inadequate handling or modification of the original geometry.

The warranty excludes liability for damage and his consequences.

- **Delivery:**

Any delivery date is calculated by Helion as short as possible but no guarantee as to the date of delivery is given or implied.

In case of delay, Helion will not accept any claim or annulations of special tools produced following customer request.

- **Jurisdiction:**

In case of dispute the consumer will be subject to the jurisdiction of the courts of Manresa.



**SPECIAL TOOL  
REQUEST FORM**

Please, send us the following  
information by email

**comercial@helion.tools**

**Drawing / Dibujo**



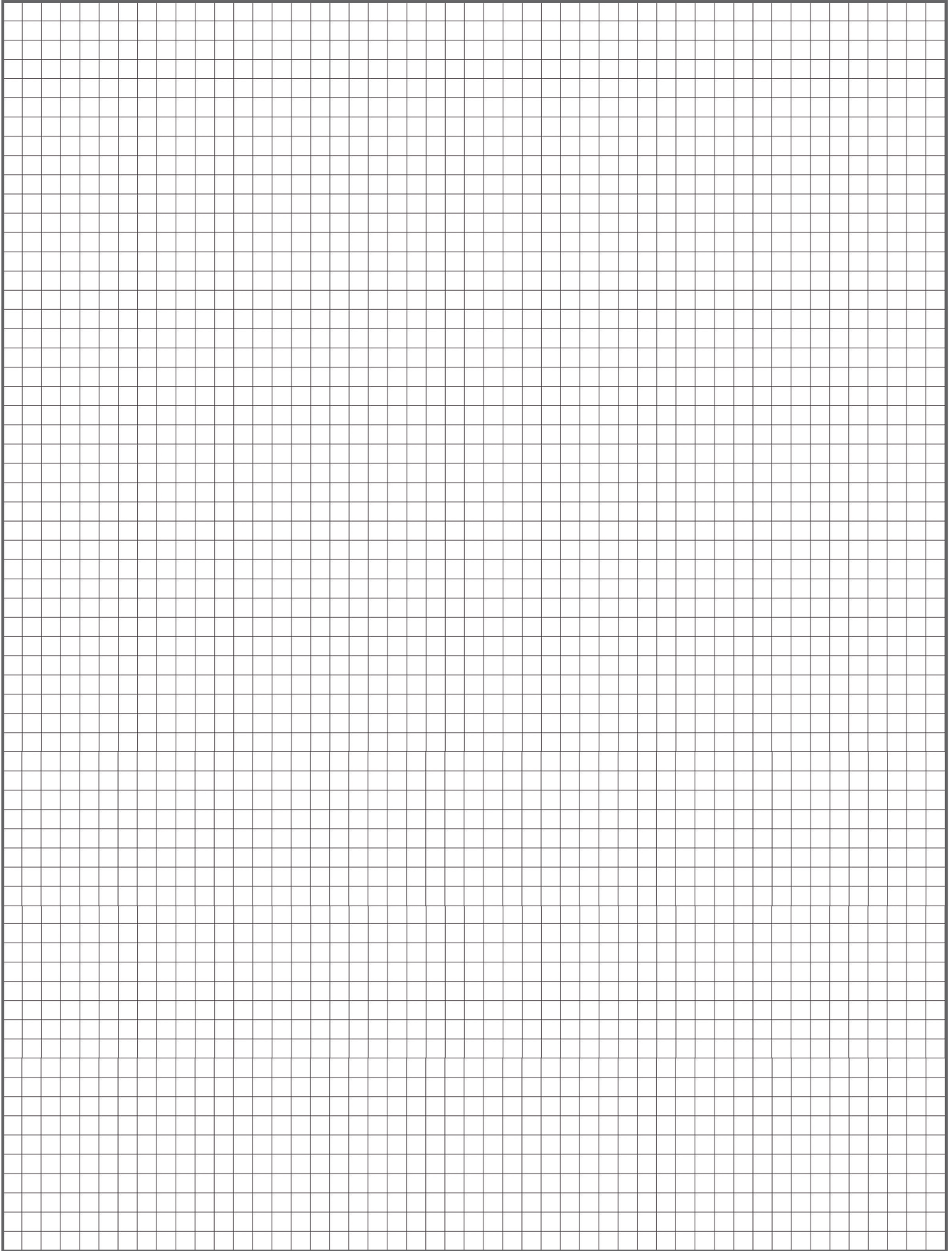

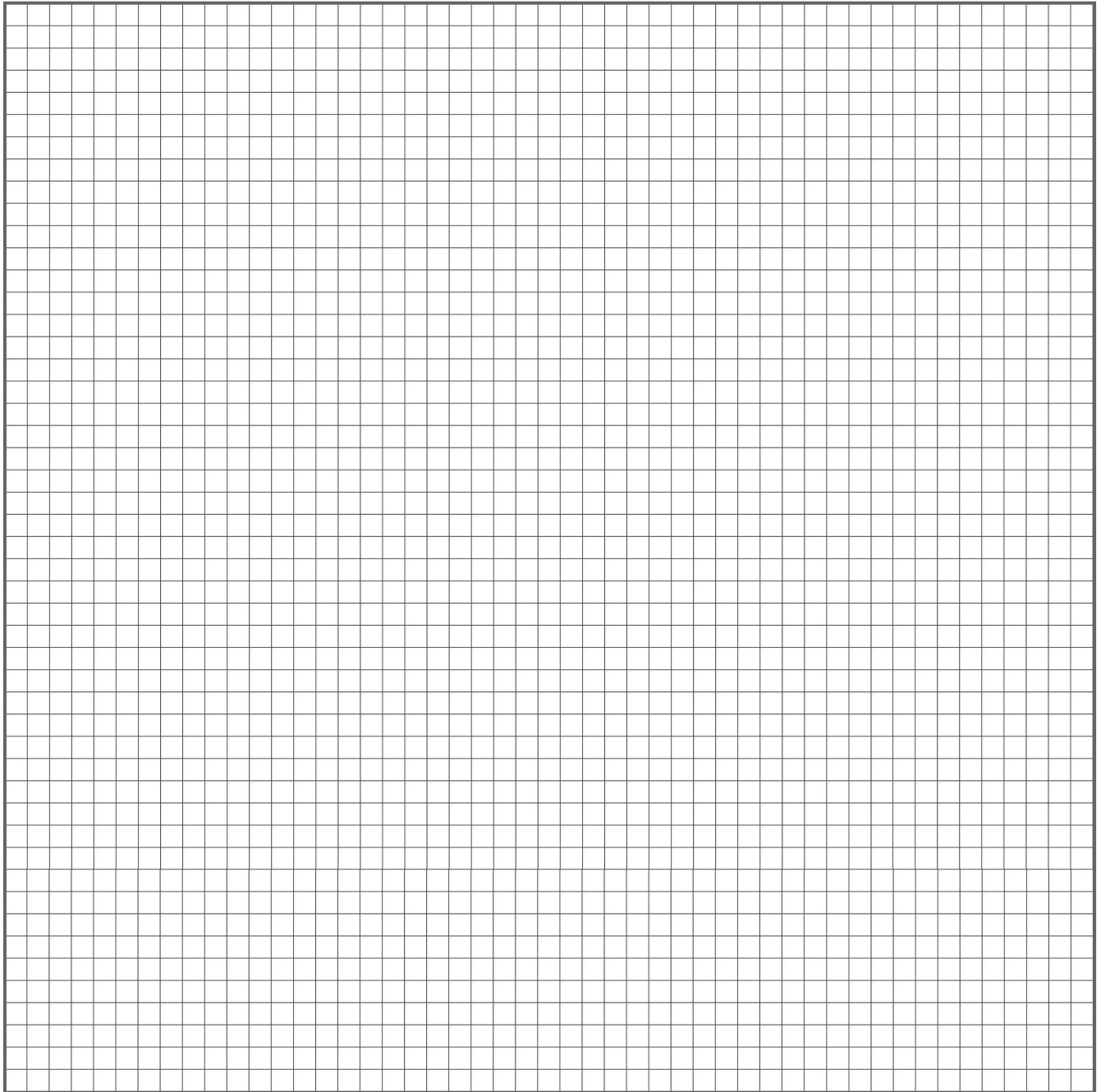

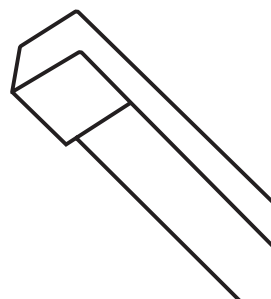
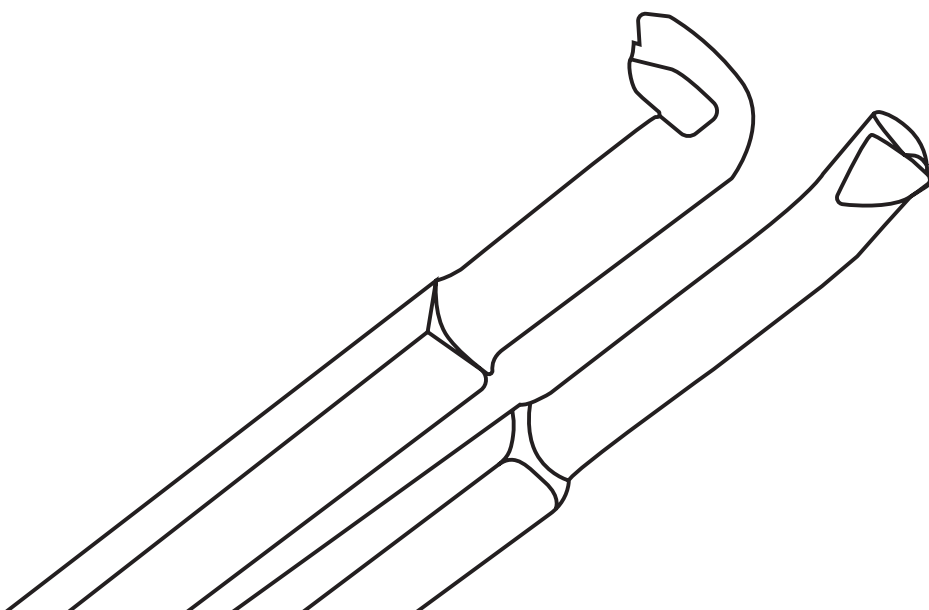
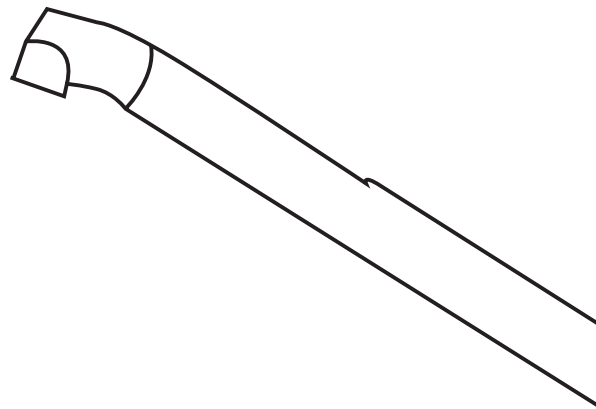
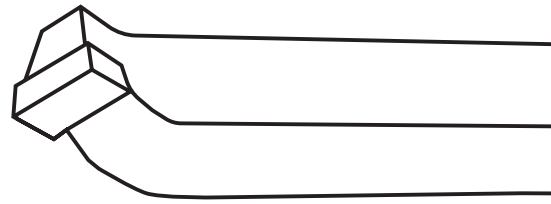
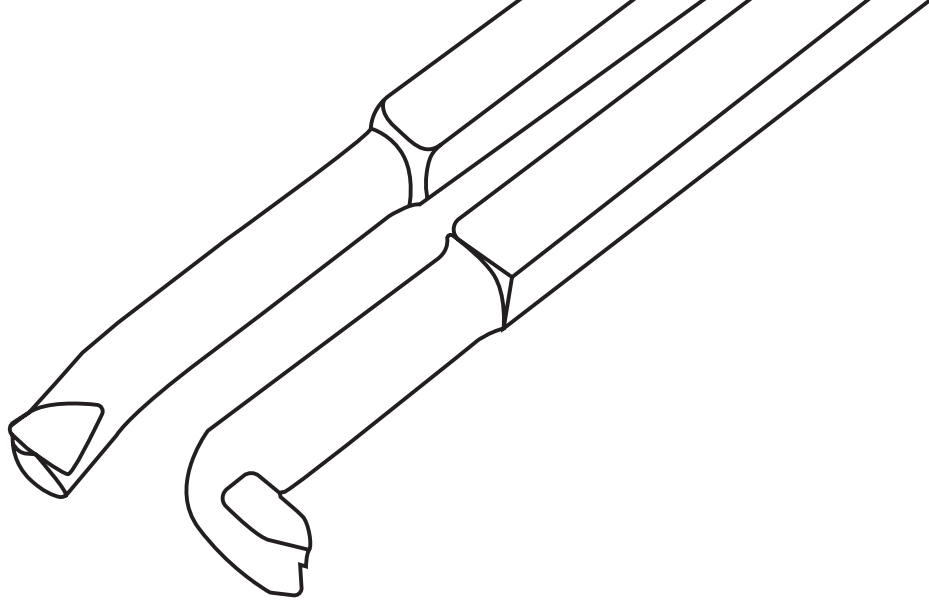
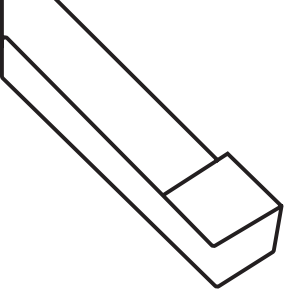



HELION TOOLS S.L.

C/ Miquel Servet 37  
Nau 13 P.I. Bufalvent  
CP 08243 · Manresa  
Barcelona · Spain

+34 93 877 08 69  
info@helion.tools  
www.helion.tools